



Simply

Josep Patsi

Sobremesa Simply GU10 8W Blanco 317lm

Características técnicas

Potencia total luminaria: 8W

Ángulo Ópticas / Reflector: MEDIUM 35°

Material de la estructura: Aluminio, Acero

Acabado estructura: Blanco

Bombilla recomendada: GU10

Voltaje / Frecuencia: 100-240V ~ 50/60Hz

Garantía: 5 años

Luminaria fácilmente reciclable

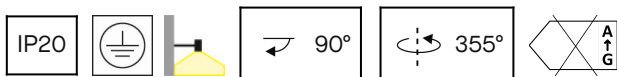

Características luminotécnicas

Portalámparas	Cantidad	Potencia fuente de luz (W)	Temperatura de color correlacionada (CCT)
GU10	1	Potencia máx. 8W	-

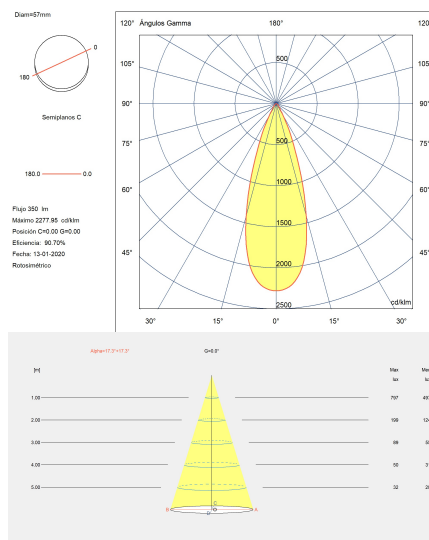
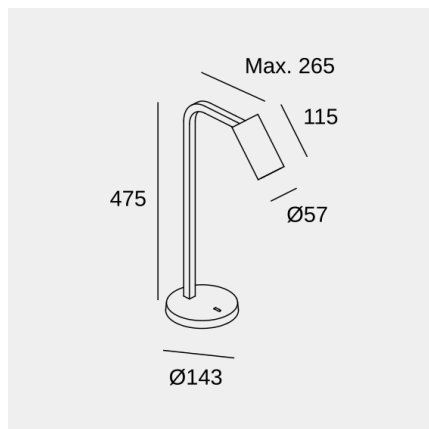

Fotometría realizada con una bombilla estándar

La imagen puede no coincidir con la referencia, LedsC4 se reserva el derecho de modificación de alguno de los componentes que componen el producto. Los datos relativos al flujo, la potencia y la temperatura de color pueden estar sujetos a cambios del fabricante.



Simply

Josep Patsi

Sobremesa Simply GU10 8W Blanco 317lm

Logística



x 4

Peso neto (Kg): 2.4

Peso embalado (Kg): 3.42

Embalaje: 520mm x 280mm x 200mm

Aplicación de la luminaria



La imagen puede no coincidir con la referencia, LedsC4 se reserva el derecho de modificación de alguno de los componentes que componen el producto. Los datos relativos al flujo, la potencia y la temperatura de color pueden estar sujetos a cambios del fabricante.

Luminaire

Code 10-7982-14-14
Name SIMPLY

Measurement

Code 10-7982-14-14
Name SIMPLY

Luminaire Flux	317 lm	Luminaire Power	4.3 W	Efficacy	73.826 lm/W	Efficiency	90.70%
Source Flux	350 lm	Maximum value	2277.95 cd/klm	Position	C=0.00 G=0.00	CG	Rotosymmetrical
Round Luminaire		Diam.	57 mm	Height	115 mm		
Round Luminous Area		Diam.	45 mm	Height	0 mm		
Horizontal Luminous Area		0.001590 m2		Emitting area on Plane 180°		0.000000 m2	
Emitting area on Plane 0°		0.000000 m2		Emitting area on Plane 270°		0.000000 m2	
Emitting area on Plane 90°		0.000000 m2		Glare area at 76°		0.000385 m2	
Coordinate system		CG		Symmetry Type		Rotosymmetrical	
Date		13-01-2020		Maximum Gamma Angle		90	
Measurement Distance		0.00		Measurement Flux		350 lm	
Operator		qualitat		Rated Voltage			
Temperature				Rated Current			
Humidity				Photocell			
Notes							

Luminaire Sources

Line	Code LED	Name	Flux [lm]	Pow. [W]	Q.ty
		P PAR 16 50 36° 4.3 W/827 GU10	350.00	4.30	1
C.I.E.	93 98 99 100 91	D DIN 5040	A60		
F UTE	0.91 A	B NBN	BZ 1		

Diam=57mm

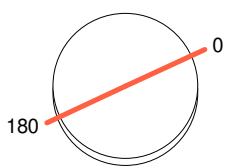

C Halfplanes

180.0 — 0.0

ULOR 0.00 %

DLOR 90.70 %

RN 0.00 %

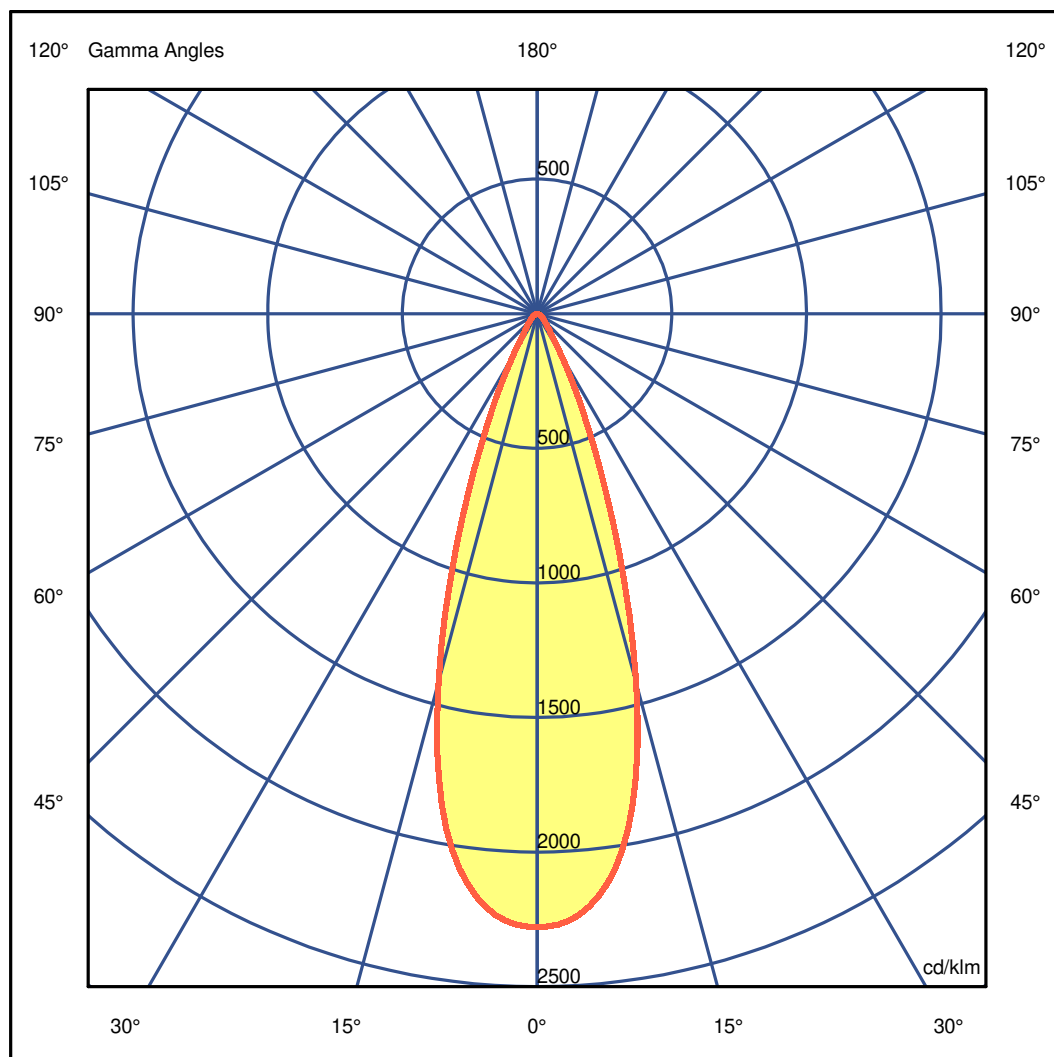

Luminaire

Code 10-7982-14-14
Name SIMPLY

Measurem.

Code 10-7982-14-14
Name SIMPLY

Luminaire Flux	317 lm	Luminaire Power	4.3 W	Efficacy	73.826 lm/W	Efficiency	90.70%
Source Flux	350 lm	Maximum value	2277.95 cd/klm	Position	C=0.00 G=0.00	CG	Rotosymmetrical

Luminous Intensity Table cd/klm Table 1/1

	C 0.00	C 0.00
G 0.0	2277.95	G 46.0 36.71
G 1.0	2276.31	G 47.0 34.49
G 2.0	2270.23	G 48.0 32.47
G 3.0	2257.34	G 49.0 30.81
G 4.0	2237.91	G 50.0 29.24
G 5.0	2210.40	G 51.0 27.77
G 6.0	2176.01	G 52.0 26.31
G 7.0	2132.71	G 53.0 24.97
G 8.0	2080.84	G 54.0 23.87
G 9.0	2017.34	G 55.0 22.74
G 10.0	1942.91	G 56.0 21.53
G 11.0	1856.52	G 57.0 20.29
G 12.0	1758.63	G 58.0 19.03
G 13.0	1653.22	G 59.0 17.70
G 14.0	1536.08	G 60.0 16.42
G 15.0	1417.48	G 61.0 15.12
G 16.0	1292.80	G 62.0 14.02
G 17.0	1170.07	G 63.0 13.00
G 18.0	1048.16	G 64.0 12.08
G 19.0	931.08	G 65.0 11.29
G 20.0	820.34	G 66.0 10.62
G 21.0	716.96	G 67.0 10.11
G 22.0	624.34	G 68.0 9.64
G 23.0	540.40	G 69.0 9.17
G 24.0	468.53	G 70.0 8.69
G 25.0	405.57	G 71.0 8.23
G 26.0	349.56	G 72.0 7.77
G 27.0	299.06	G 73.0 7.31
G 28.0	252.63	G 74.0 6.86
G 29.0	212.16	G 75.0 6.40
G 30.0	178.99	G 76.0 5.95
G 31.0	151.63	G 77.0 5.50
G 32.0	126.78	G 78.0 5.05
G 33.0	107.29	G 79.0 4.60
G 34.0	92.89	G 80.0 4.16
G 35.0	84.92	G 81.0 3.72
G 36.0	78.34	G 82.0 3.28
G 37.0	72.20	G 83.0 2.83
G 38.0	66.37	G 84.0 2.38
G 39.0	61.11	G 85.0 1.93
G 40.0	56.22	G 86.0 1.49
G 41.0	51.88	G 87.0 1.10
G 42.0	48.14	G 88.0 0.78
G 43.0	44.69	G 89.0 0.55
G 44.0	41.76	G 90.0 0.31
G 45.0	39.06	

LedsC4

Luminaire

Code 10-7982-14-14
Name SIMPLY

Measur.

Code 10-7982-14-14
Name SIMPLY

Luminaire Flux	317 lm	Luminaire Power	4.3 W	Efficacy	73.826 lm/W	Efficiency	90.70%
Source Flux	350 lm	Maximum value	2277.95 cd/klm	Position	C=0.00 G=0.00	CG	Rotosymmetrical

Diam=57mm

C Halfplanes

180.0  0.0

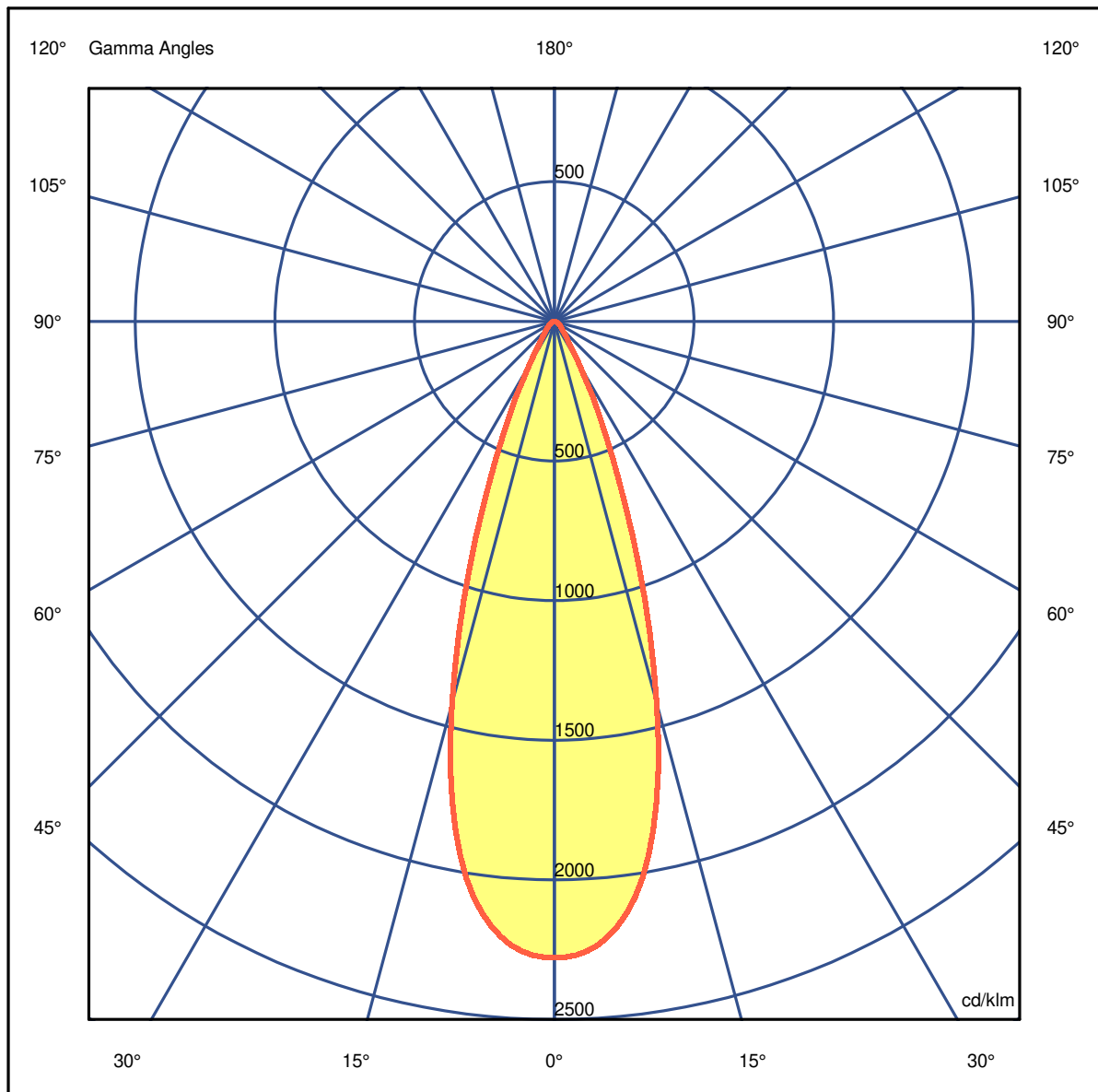
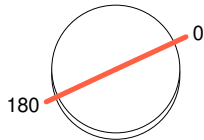

LedsC4

Luminaire

Code 10-7982-14-14
Name SIMPLY

Measurem.

Code 10-7982-14-14
Name SIMPLY

Luminaire Flux	317 lm	Luminaire Power	4.3 W	Efficacy	73.826 lm/W	Efficiency	90.70%
Source Flux	350 lm	Maximum value	2277.95 cd/klm	Position	C=0.00 G=0.00	CG	Rotosymmetrical

Diam=57mm

C Halfplanes

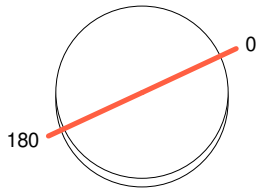

180.0 ————— 0.0

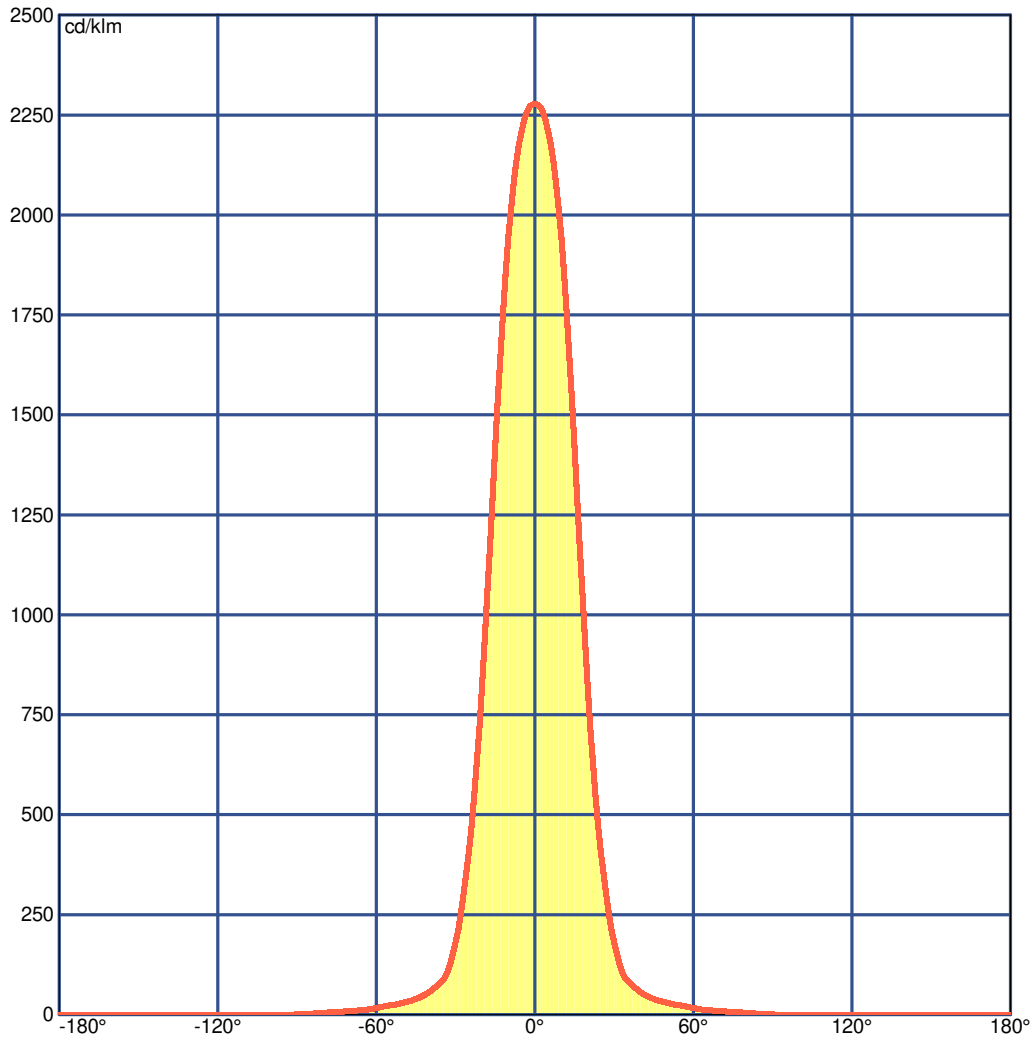

Luminaire

Code 10-7982-14-14
Name SIMPLY

Measurem.

Code 10-7982-14-14
Name SIMPLY

Luminaire Flux	317 lm	Luminaire Power	4.3 W	Efficacy	73.826 lm/W	Efficiency	90.70%
Source Flux	350 lm	Maximum value	2277.95 cd/klm	Position	C=0.00 G=0.00	CG	Rotosymmetrical

UGR
S = 0.250

Reflectancies										
Ceiling/Cavity	0.7	0.7	0.5	0.5	0.3	0.7	0.7	0.5	0.5	0.3
Walls	0.5	0.3	0.5	0.3	0.3	0.5	0.3	0.5	0.3	0.3
Working Plane	0.2	0.2	0.2	0.2	0.2	0.2	0.2	0.2	0.2	0.2
Room Dimensions	Lateral View					Viewed Endwise				
x=2H y=2H	14.4	15.1	14.6	15.3	15.5	14.4	15.1	14.6	15.3	15.5
x=2H y=3H	15.0	15.7	15.3	15.9	16.2	15.0	15.7	15.3	15.9	16.2
x=2H y=4H	15.4	16.0	15.7	16.3	16.5	15.4	16.0	15.7	16.3	16.5
x=2H y=6H	15.7	16.3	16.0	16.6	16.8	15.7	16.3	16.0	16.6	16.8
x=2H y=8H	15.8	16.4	16.2	16.7	17.0	15.8	16.4	16.2	16.7	17.0
x=2H y=12H	15.9	16.4	16.3	16.7	17.0	15.9	16.4	16.3	16.7	17.0
x=4H y=2H	14.6	15.2	14.9	15.5	15.8	14.6	15.2	14.9	15.5	15.8
x=4H y=3H	15.5	16.0	15.9	16.3	16.6	15.5	16.0	15.9	16.3	16.6
x=4H y=4H	16.0	16.5	16.4	16.8	17.1	16.0	16.5	16.4	16.8	17.1
x=4H y=6H	16.5	16.8	16.9	17.2	17.6	16.5	16.8	16.9	17.2	17.6
x=4H y=8H	16.6	17.0	17.1	17.4	17.8	16.6	17.0	17.1	17.4	17.8
x=4H y=12H	16.8	17.1	17.2	17.5	17.9	16.8	17.1	17.2	17.5	17.9
x=8H y=4H	16.2	16.5	16.6	16.9	17.3	16.2	16.5	16.6	16.9	17.3
x=8H y=6H	16.8	17.0	17.2	17.4	17.9	16.8	17.0	17.2	17.4	17.9
x=8H y=8H	17.0	17.2	17.5	17.7	18.2	17.0	17.2	17.5	17.7	18.2
x=8H y=12H	17.2	17.4	17.7	17.9	18.4	17.2	17.4	17.7	17.9	18.4
x=12H y=4H	16.2	16.5	16.6	16.9	17.3	16.2	16.5	16.6	16.9	17.3
x=12H y=6H	16.8	17.0	17.3	17.5	17.9	16.8	17.0	17.3	17.5	17.9
x=12H y=8H	17.1	17.3	17.6	17.7	18.2	17.1	17.3	17.6	17.7	18.2

Luminaire

Code 10-7982-14-14
Name SIMPLY

Measurement

Code 10-7982-14-14
Name SIMPLY

Luminaire Flux	317 lm	Luminaire Power	4.3 W	Efficacy	73.826 lm/W	Efficiency	90.70%
Source Flux	350 lm	Maximum value	2277.95 cd/klm	Position	C=0.00 G=0.00	CG	Rotosymmetrical

Total Flux=350.00 Luminaire Flux=317.45

RI	0.60	0.80	1.00	1.25	1.50	2.00	2.50	3.00	4.00	5.00	10.00	20.00
DRR	0.68	0.73	0.78	0.82	0.85	0.90	0.93	0.95	0.97	0.98	1.01	1.02
RC	-	-	-	-	-	-	-	-	-	-	-	-

Zonal Flux per 1000 Lumen

Y°	10	20	30	40	50	60	70	80	90	100	110	120	130	140	150	160	170	180
ZF(Y)	203	583	776	835	866	886	898	905	907	907	907	907	907	907	907	907	907	907

CIE Flux Codes

93 98 99 100 91

C.I.E.	-/-/-/-/-/-/-/-/-/-	LOR	90.70000 %
D DIN 5040	A60	ULOR	0.00000 %
F UTE	0.91 A	DLOR	90.70000 %
B NBN	BZ 1	UFF	0.00000 %
RN	0.00000 %	DFF	100.00000 %
BLF	1.0	FFR	0.00000 %

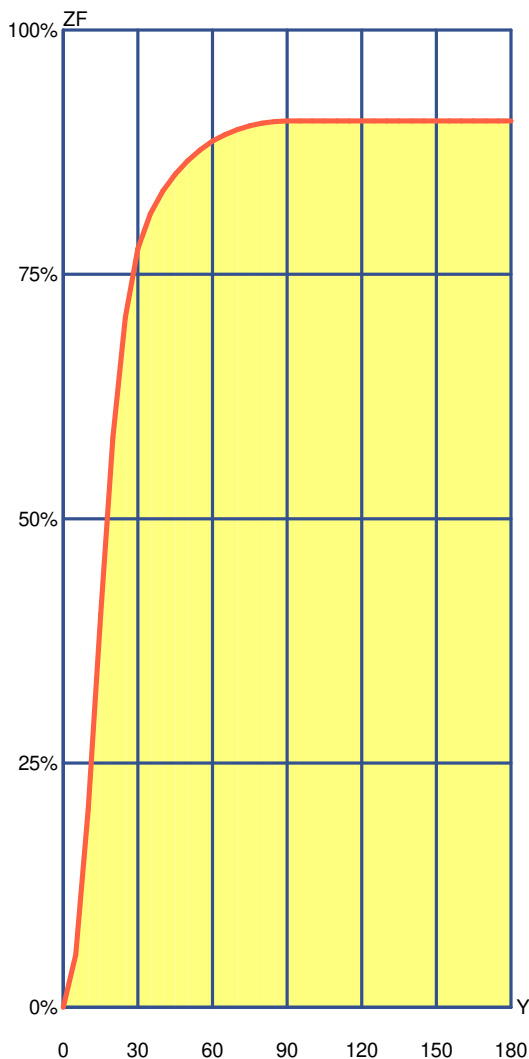

Gamma °	Zonal Flux			
	Flux	Sum lm	Flux [%]	Sum [%]
0°	0.00	0.00	0.00%	0.00 %
5°	53.72	53.72	5.92 %	5.92 %
10°	149.00	202.72	16.43 %	22.35 %
15°	199.34	402.06	21.98 %	44.33 %
20°	181.13	583.19	19.97 %	64.30 %
25°	122.85	706.04	13.54 %	77.84 %
30°	70.38	776.42	7.76 %	85.60 %
35°	35.65	812.08	3.93 %	89.53 %
40°	23.18	835.25	2.56 %	92.09 %
45°	17.29	852.55	1.91 %	94.00 %
50°	13.60	866.15	1.50 %	95.50 %
55°	11.20	877.35	1.23 %	96.73 %
60°	9.06	886.41	1.00 %	97.73 %
65°	6.61	893.02	0.73 %	98.46 %
70°	5.01	898.03	0.55 %	99.01 %
75°	3.94	901.97	0.43 %	99.45 %
80°	2.82	904.79	0.31 %	99.76 %
85°	1.66	906.45	0.18 %	99.94 %
90°	0.55	907.00	0.06 %	100.00 %
95°	0.00	907.00	0.00 %	100.00 %
100°	0.00	907.00	0.00 %	100.00 %
105°	0.00	907.00	0.00 %	100.00 %
110°	0.00	907.00	0.00 %	100.00 %
115°	0.00	907.00	0.00 %	100.00 %
120°	0.00	907.00	0.00 %	100.00 %
125°	0.00	907.00	0.00 %	100.00 %
130°	0.00	907.00	0.00 %	100.00 %
135°	0.00	907.00	0.00 %	100.00 %
140°	0.00	907.00	0.00 %	100.00 %
145°	0.00	907.00	0.00 %	100.00 %
150°	0.00	907.00	0.00 %	100.00 %
155°	0.00	907.00	0.00 %	100.00 %
160°	0.00	907.00	0.00 %	100.00 %
165°	0.00	907.00	0.00 %	100.00 %
170°	0.00	907.00	0.00 %	100.00 %
175°	0.00	907.00	0.00 %	100.00 %
180°	0.00	907.00	0.00 %	100.00 %

Luminaire

Code 10-7982-14-14
Name SIMPLY

Measurement

Code 10-7982-14-14
Name SIMPLY

Luminaire Flux	317 lm	Luminaire Power	4.3 W	Efficacy	73.826 lm/W	Efficiency	90.70%
Source Flux	350 lm	Maximum value	2277.95 cd/klm	Position	C=0.00 G=0.00	CG	Rotosymmetrical

Utilizations CIE

Mounting	Direct	Normalization										Normalised										Suspension Ratid/3										Standard CIE Settings									
Ceiling																																									
K	8873	8773	8871	8771	7773	7771	7753	7553	7751	7551	7731	7331	7711	7111	5551	5531	5331	5511	5111	3331	3311	1111	0000																		
0.60	152	136	90	82	130	78	87	74	49	42	30	23	16	11	39	24	21	13	10	20	11	10	0																		
0.80	182	167	98	90	159	86	113	99	58	51	38	30	23	17	48	32	29	19	16	27	17	15	0																		
1.00	203	189	99	93	180	89	135	121	63	57	44	36	29	22	53	37	34	25	21	33	22	20	0																		
1.25	224	210	100	95	200	91	158	143	68	62	50	43	36	29	58	44	41	31	27	39	28	25	0																		
1.50	239	227	100	96	216	92	176	162	72	66	55	48	42	34	62	49	46	37	33	44	33	30	0																		
2.00	260	250	97	94	238	91	204	191	75	71	62	55	51	44	67	56	53	46	42	51	42	39	0																		
2.50	274	265	94	92	253	89	224	212	77	73	67	61	58	51	70	61	58	53	49	56	49	46	0																		
3.00	284	276	92	90	264	88	239	228	78	75	70	65	63	56	72	65	62	58	55	60	55	51	0																		
4.00	298	292	91	90	280	88	260	251	81	79	75	71	70	64	76	70	69	66	62	66	62	59	0																		
5.00	308	303	91	90	290	88	274	266	83	81	79	75	75	70	78	74	73	71	68	70	67	64	0																		
10.00	329	326	91	90	313	89	306	301	88	87	87	85	86	83	84	83	82	82	81	80	80	77	0																		
20.00	341	340	91	91	326	90	324	321	90	90	91	90	92	90	88	88	88	89	88	86	87	84	0																		

Wall

K	8873	8773	8871	8771	7773	7771	7753	7553	7751	7551	7731	7331	7711	7111	5551	5531	5331	5511	5111	3331	3311	1111	0000
0.60	272	264	195	190	260	188	205	199	152	148	127	124	109	108	147	125	124	108	107	123	107	107	87
0.80	304	295	208	204	288	200	235	227	167	164	143	140	126	123	161	140	139	124	122	138	122	121	98
1.00	319	310	207	203	301	199	251	243	170	167	149	145	132	129	164	145	143	130	128	141	128	126	99
1.25	335	326	207	204	315	200	269	260	175	171	155	151	139	136	167	150	148	136	134	146	134	132	102
1.50	346	337	206	203	325	199	282	273	177	173	159	155	144	140	169	153	152	140	138	149	137	135	103
2.00	348	340	190	187	325	183	289	280	166	163	152	148	141	136	158	146	144	136	133	140	131	128	93
2.50	343	336	172	171	319	166	289	280	153	151	142	138	133	128	144	135	133	127	124	129	122	117	80
3.00	334	328	154	152	309	148	284	275	138	136	129	126	122	117	129	122	120	115	113	115	109	104	65
4.00	329	324	137	136	303	131	283	275	124	122	118	114	112	108	115	109	108	105	102	102	98	92	51
5.00	322	317	122	121	295	116	279	272	111	109	106	103	102	98	101	97	96	94	92	90	87	80	37
10.00	270	267	53	53	242	48	234	230	47	46	45	44	44	42	36	36	35	35	33	27	26	18	0
20.00	168	166	0	0	139	0	137	134	0	0	0	0	0	0	0	0	0	0	0	0	0	0	0

Working Pl.

K	8873	8773	8871	8771	7773	7771	7753	7553	7751	7551	7731	7331	7711	7111	5551	5531	5331	5511	5111	3331	3311	1111	0000
0.60	791	782	738	733	777	730	710	704	683	680	652	649	629	627	678	649	648	628	627	647	627	626	618
0.80	853	842	785	780	834	776	767	759	732	728	700	696	677	674	724	696	694	674	673	693	673	671	663
1.00	906	895	826	821	884	816	821	811	776	772	747	742	724	720	767	741	739	721	719	737	718	716	708
1.25	951	940	857	853	925	846	867	855	812	807	785	779	763	758	801	777	775	758	756	772	755	752	744
1.50	984	973	879	875	956	868	901	889	837	833	812	807	792	787	825	804	802	786	783	797	781	778	770
2.00	1000	1000	912	909	1000	902	958	946	878	874	858	852	842	835	864	848	846	834	830	839	827	821	814
2.50	1000	1000	932	930	1000	922	996	984	904	900	888	883	875	868	889	877	874	865	862	867	857	850	843
3.00	1000	1000	946	944	1000	936	1000	1000	922	919	910	904	899	892	907	897	895	888	884	886	878	870	863
4.00	1000	1000	960	958	1000	949	1000	1000	940	937	931	926	923	916	924	916	914	910	906	904	898	888	882
5.00	1000	1000	967	966	1000	957	1000	1000	950	947	943	939	937	931	933	928	926	923	920	914	910	899	892
10.00	1000	1000	982	981	1000	972	1000	1000	970	969	969	966	967	964	952	951	950	950	948	935	935	920	913
20.00	1000	1000	988	988	1000	978	1000	1000	980	979	981	979	982	979	961	962	961	963	962	944	945	928	921

LM53 SHR C0-C180: 0.573 SHR C90-C270: 0.573 SHR Square: 0.551

LedsC4

Luminaire

Code 10-7982-14-14
Name SIMPLY

Measurement

Code 10-7982-14-14
Name SIMPLY

Luminaire Flux	317 lm	Luminaire Power	4.3 W	Efficacy	73.826 lm/W	Efficiency	90.70%
Source Flux	350 lm	Maximum value	2277.95 cd/klm	Position	C=0.00 G=0.00	CG	Rotosymmetrical

Width at 50.00 % of Max Intensity

H[m]	1.00	2.00	3.00	4.00	5.00	H[m]	1.00	2.00	3.00	4.00	5.00
OA	0.31	0.62	0.93	1.24	1.55	OC	0.31	0.62	0.93	1.24	1.55
OB	0.31	0.62	0.93	1.24	1.55	OD	0.31	0.62	0.93	1.24	1.55

	Luminous Intensities [cd/klm]									
	0	5	15	25	35	45	55	65	75	85
OA	797.28	773.64	496.12	141.95	29.72	13.67	7.96	3.95	2.24	0.68
OB	797.28	773.64	496.12	141.95	29.72	13.67	7.96	3.95	2.24	0.68
OC	797.28	773.64	496.12	141.95	29.72	13.67	7.96	3.95	2.24	0.68
OD	797.28	773.64	496.12	141.95	29.72	13.67	7.96	3.95	2.24	0.68

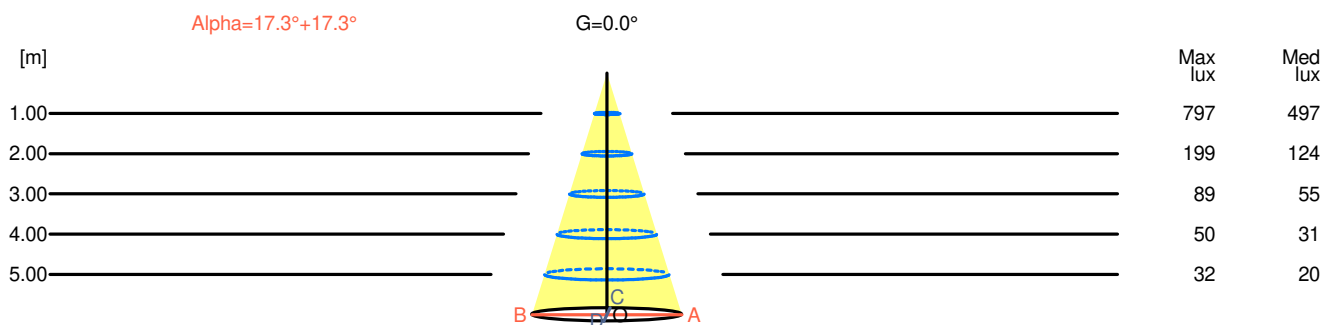

H[m]	D[m]	Max lux	Med lux	Alpha=17.3°+17.3°	G=0.0
1.00	0.62	797	497		
2.00	1.24	199	124		
3.00	1.86	89	55		
4.00	2.48	50	31		
5.00	3.11	32	20		

Luminaire

Code 10-7982-14-14
Name SIMPLY

Measurem.

Code 10-7982-14-14
Name SIMPLY

Luminaire Flux	317 lm	Luminaire Power	4.3 W	Efficacy	73.826 lm/W	Efficiency	90.70%
Source Flux	350 lm	Maximum value	2277.95 cd/klm	Position	C=0.00 G=0.00	CG	Rotosymmetrical

Isolux (Floor)

Luminaire position X=0.00m Y=0.00m Z=2.50m

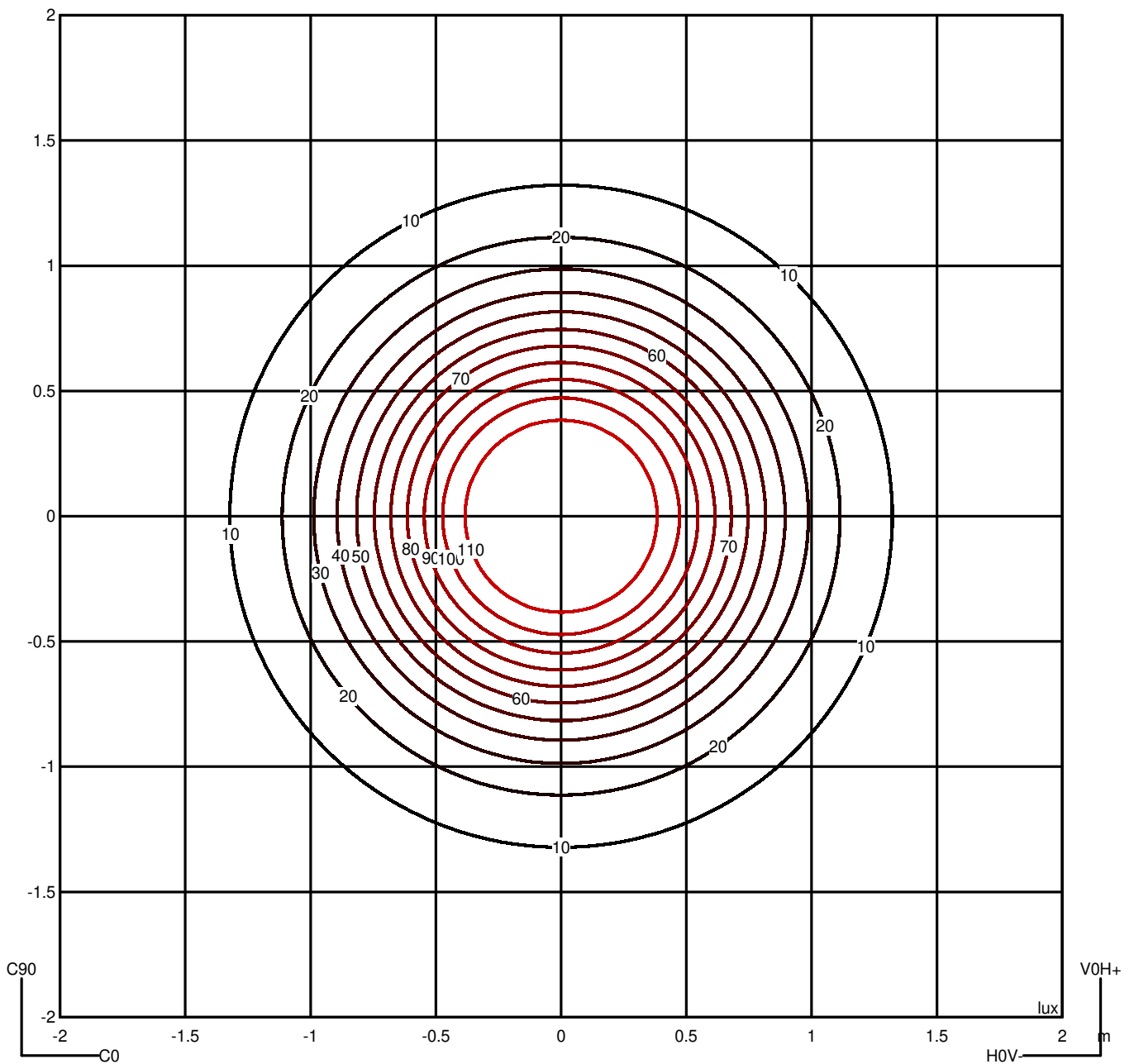

LedsC4

Luminaire

Code 10-7982-14-14
Name SIMPLY

Measurem.

Code 10-7982-14-14
Name SIMPLY

Luminaire Flux	317 lm	Luminaire Power	4.3 W	Efficacy	73.826 lm/W	Efficiency	90.70%
Source Flux	350 lm	Maximum value	2277.95 cd/klm	Position	C=0.00 G=0.00	CG	Rotosymmetrical

Luminance

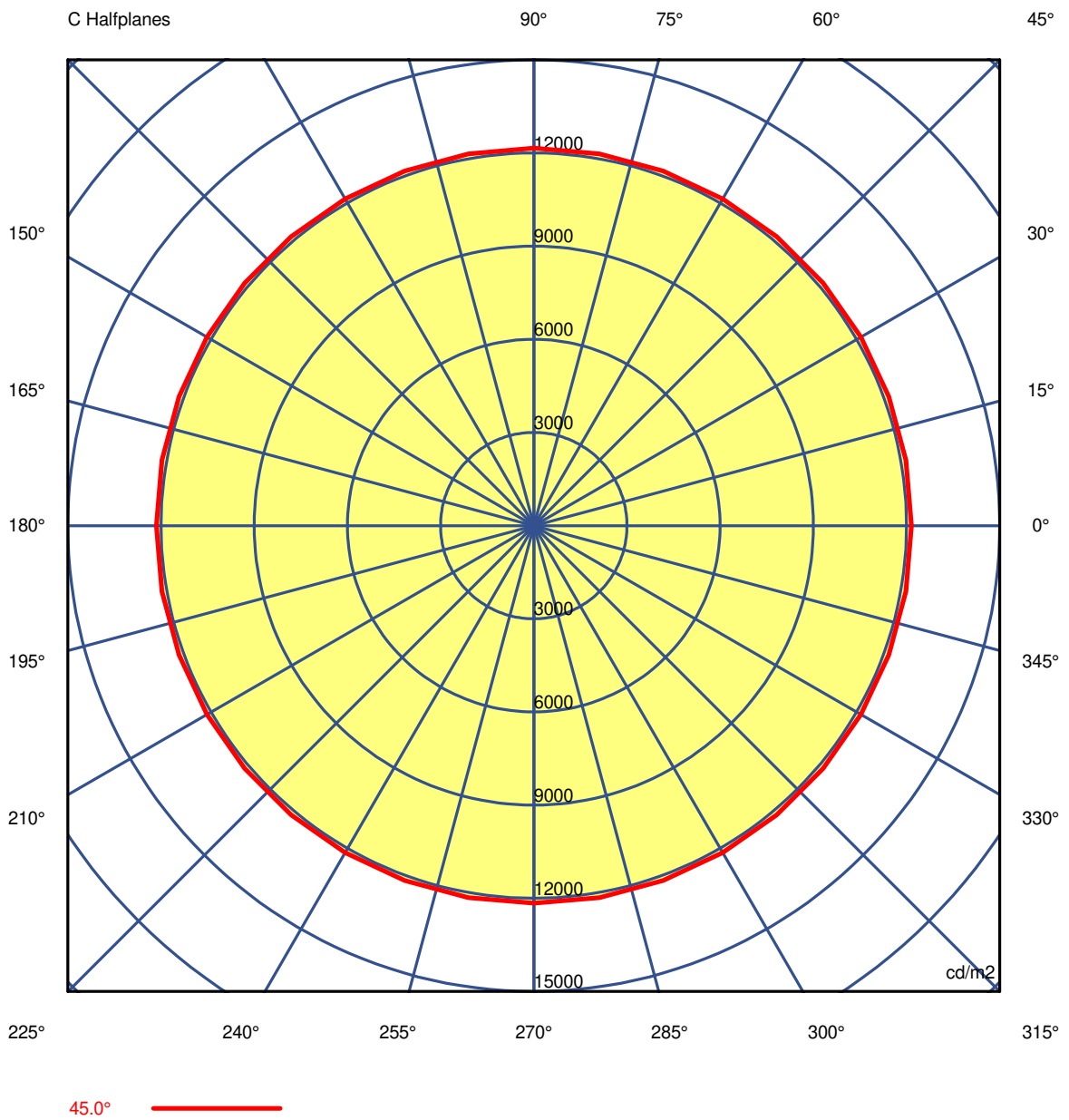

Luminaire

Code 10-7982-14-14
Name SIMPLY

Measurement

Code 10-7982-14-14
Name SIMPLY

Luminaire Flux	317 lm	Luminaire Power	4.3 W	Efficacy	73.826 lm/W	Efficiency	90.70%
Source Flux	350 lm	Maximum value	2277.95 cd/klm	Position	C=0.00 G=0.00	CG	Rotosymmetrical

Luminance cd/m2 Table 1/3

	C 0.00	C 10.00	C 20.00	C 30.00	C 40.00	C 50.00	C 60.00	C 70.00	C 80.00	C 90.00	C 100.00	C 110.00	C 120.00
G 0.0	501299.83	501299.83	501299.83	501299.83	501299.83	501299.83	501299.83	501299.83	501299.83	501299.83	501299.83	501299.83	501299.83
G 5.0	488293.21	488293.21	488293.21	488293.21	488293.21	488293.21	488293.21	488293.21	488293.21	488293.21	488293.21	488293.21	488293.21
G 10.0	434164.03	434164.03	434164.03	434164.03	434164.03	434164.03	434164.03	434164.03	434164.03	434164.03	434164.03	434164.03	434164.03
G 15.0	322942.67	322942.67	322942.67	322942.67	322942.67	322942.67	322942.67	322942.67	322942.67	322942.67	322942.67	322942.67	322942.67
G 20.0	192114.76	192114.76	192114.76	192114.76	192114.76	192114.76	192114.76	192114.76	192114.76	192114.76	192114.76	192114.76	192114.76
G 25.0	98479.70	98479.70	98479.70	98479.70	98479.70	98479.70	98479.70	98479.70	98479.70	98479.70	98479.70	98479.70	98479.70
G 30.0	45482.93	45482.93	45482.93	45482.93	45482.93	45482.93	45482.93	45482.93	45482.93	45482.93	45482.93	45482.93	45482.93
G 35.0	22814.07	22814.07	22814.07	22814.07	22814.07	22814.07	22814.07	22814.07	22814.07	22814.07	22814.07	22814.07	22814.07
G 40.0	16151.96	16151.96	16151.96	16151.96	16151.96	16151.96	16151.96	16151.96	16151.96	16151.96	16151.96	16151.96	16151.96
G 45.0	12157.55	12157.55	12157.55	12157.55	12157.55	12157.55	12157.55	12157.55	12157.55	12157.55	12157.55	12157.55	12157.55
G 50.0	10009.95	10009.95	10009.95	10009.95	10009.95	10009.95	10009.95	10009.95	10009.95	10009.95	10009.95	10009.95	10009.95
G 55.0	8725.98	8725.98	8725.98	8725.98	8725.98	8725.98	8725.98	8725.98	8725.98	8725.98	8725.98	8725.98	8725.98
G 60.0	7224.97	7224.97	7224.97	7224.97	7224.97	7224.97	7224.97	7224.97	7224.97	7224.97	7224.97	7224.97	7224.97
G 65.0	5877.56	5877.56	5877.56	5877.56	5877.56	5877.56	5877.56	5877.56	5877.56	5877.56	5877.56	5877.56	5877.56
G 70.0	5593.37	5593.37	5593.37	5593.37	5593.37	5593.37	5593.37	5593.37	5593.37	5593.37	5593.37	5593.37	5593.37
G 75.0	5443.65	5443.65	5443.65	5443.65	5443.65	5443.65	5443.65	5443.65	5443.65	5443.65	5443.65	5443.65	5443.65
G 80.0	5274.61	5274.61	5274.61	5274.61	5274.61	5274.61	5274.61	5274.61	5274.61	5274.61	5274.61	5274.61	5274.61
G 85.0	4880.37	4880.37	4880.37	4880.37	4880.37	4880.37	4880.37	4880.37	4880.37	4880.37	4880.37	4880.37	4880.37
G 90.0	0.00	0.00	0.00	0.00	0.00	0.00	0.00	0.00	0.00	0.00	0.00	0.00	0.00

Luminaire

Code 10-7982-14-14
Name SIMPLY

Measurement

Code 10-7982-14-14
Name SIMPLY

Luminaire Flux	317 lm	Luminaire Power	4.3 W	Efficacy	73.826 lm/W	Efficiency	90.70%
Source Flux	350 lm	Maximum value	2277.95 cd/klm	Position	C=0.00 G=0.00	CG	Rotosymmetrical

Luminance cd/m2 Table 2/3

	C 130.00	C 140.00	C 150.00	C 160.00	C 170.00	C 180.00	C 190.00	C 200.00	C 210.00	C 220.00	C 230.00	C 240.00	C 250.00
G 0.0	501299.83	501299.83	501299.83	501299.83	501299.83	501299.83	501299.83	501299.83	501299.83	501299.83	501299.83	501299.83	501299.83
G 5.0	488293.21	488293.21	488293.21	488293.21	488293.21	488293.21	488293.21	488293.21	488293.21	488293.21	488293.21	488293.21	488293.21
G 10.0	434164.03	434164.03	434164.03	434164.03	434164.03	434164.03	434164.03	434164.03	434164.03	434164.03	434164.03	434164.03	434164.03
G 15.0	322942.67	322942.67	322942.67	322942.67	322942.67	322942.67	322942.67	322942.67	322942.67	322942.67	322942.67	322942.67	322942.67
G 20.0	192114.76	192114.76	192114.76	192114.76	192114.76	192114.76	192114.76	192114.76	192114.76	192114.76	192114.76	192114.76	192114.76
G 25.0	98479.70	98479.70	98479.70	98479.70	98479.70	98479.70	98479.70	98479.70	98479.70	98479.70	98479.70	98479.70	98479.70
G 30.0	45482.93	45482.93	45482.93	45482.93	45482.93	45482.93	45482.93	45482.93	45482.93	45482.93	45482.93	45482.93	45482.93
G 35.0	22814.07	22814.07	22814.07	22814.07	22814.07	22814.07	22814.07	22814.07	22814.07	22814.07	22814.07	22814.07	22814.07
G 40.0	16151.96	16151.96	16151.96	16151.96	16151.96	16151.96	16151.96	16151.96	16151.96	16151.96	16151.96	16151.96	16151.96
G 45.0	12157.55	12157.55	12157.55	12157.55	12157.55	12157.55	12157.55	12157.55	12157.55	12157.55	12157.55	12157.55	12157.55
G 50.0	10009.95	10009.95	10009.95	10009.95	10009.95	10009.95	10009.95	10009.95	10009.95	10009.95	10009.95	10009.95	10009.95
G 55.0	8725.98	8725.98	8725.98	8725.98	8725.98	8725.98	8725.98	8725.98	8725.98	8725.98	8725.98	8725.98	8725.98
G 60.0	7224.97	7224.97	7224.97	7224.97	7224.97	7224.97	7224.97	7224.97	7224.97	7224.97	7224.97	7224.97	7224.97
G 65.0	5877.56	5877.56	5877.56	5877.56	5877.56	5877.56	5877.56	5877.56	5877.56	5877.56	5877.56	5877.56	5877.56
G 70.0	5593.37	5593.37	5593.37	5593.37	5593.37	5593.37	5593.37	5593.37	5593.37	5593.37	5593.37	5593.37	5593.37
G 75.0	5443.65	5443.65	5443.65	5443.65	5443.65	5443.65	5443.65	5443.65	5443.65	5443.65	5443.65	5443.65	5443.65
G 80.0	5274.61	5274.61	5274.61	5274.61	5274.61	5274.61	5274.61	5274.61	5274.61	5274.61	5274.61	5274.61	5274.61
G 85.0	4880.37	4880.37	4880.37	4880.37	4880.37	4880.37	4880.37	4880.37	4880.37	4880.37	4880.37	4880.37	4880.37
G 90.0	0.00	0.00	0.00	0.00	0.00	0.00	0.00	0.00	0.00	0.00	0.00	0.00	0.00

Luminaire

Code 10-7982-14-14
Name SIMPLY

Measur.

Code 10-7982-14-14
Name SIMPLY

Luminaire Flux	317 lm	Luminaire Power	4.3 W	Efficacy	73.826 lm/W	Efficiency	90.70%
Source Flux	350 lm	Maximum value	2277.95 cd/klm	Position	C=0.00 G=0.00	CG	Rotosymmetrical

Luminance cd/m2 Table 3/3

	C 260.00	C 270.00	C 280.00	C 290.00	C 300.00	C 310.00	C 320.00	C 330.00	C 340.00	C 350.00
G 0.0	501299.83	501299.83	501299.83	501299.83	501299.83	501299.83	501299.83	501299.83	501299.83	501299.83
G 5.0	488293.21	488293.21	488293.21	488293.21	488293.21	488293.21	488293.21	488293.21	488293.21	488293.21
G 10.0	434164.03	434164.03	434164.03	434164.03	434164.03	434164.03	434164.03	434164.03	434164.03	434164.03
G 15.0	322942.67	322942.67	322942.67	322942.67	322942.67	322942.67	322942.67	322942.67	322942.67	322942.67
G 20.0	192114.76	192114.76	192114.76	192114.76	192114.76	192114.76	192114.76	192114.76	192114.76	192114.76
G 25.0	98479.70	98479.70	98479.70	98479.70	98479.70	98479.70	98479.70	98479.70	98479.70	98479.70
G 30.0	45482.93	45482.93	45482.93	45482.93	45482.93	45482.93	45482.93	45482.93	45482.93	45482.93
G 35.0	22814.07	22814.07	22814.07	22814.07	22814.07	22814.07	22814.07	22814.07	22814.07	22814.07
G 40.0	16151.96	16151.96	16151.96	16151.96	16151.96	16151.96	16151.96	16151.96	16151.96	16151.96
G 45.0	12157.55	12157.55	12157.55	12157.55	12157.55	12157.55	12157.55	12157.55	12157.55	12157.55
G 50.0	10009.95	10009.95	10009.95	10009.95	10009.95	10009.95	10009.95	10009.95	10009.95	10009.95
G 55.0	8725.98	8725.98	8725.98	8725.98	8725.98	8725.98	8725.98	8725.98	8725.98	8725.98
G 60.0	7224.97	7224.97	7224.97	7224.97	7224.97	7224.97	7224.97	7224.97	7224.97	7224.97
G 65.0	5877.56	5877.56	5877.56	5877.56	5877.56	5877.56	5877.56	5877.56	5877.56	5877.56
G 70.0	5593.37	5593.37	5593.37	5593.37	5593.37	5593.37	5593.37	5593.37	5593.37	5593.37
G 75.0	5443.65	5443.65	5443.65	5443.65	5443.65	5443.65	5443.65	5443.65	5443.65	5443.65
G 80.0	5274.61	5274.61	5274.61	5274.61	5274.61	5274.61	5274.61	5274.61	5274.61	5274.61
G 85.0	4880.37	4880.37	4880.37	4880.37	4880.37	4880.37	4880.37	4880.37	4880.37	4880.37
G 90.0	0.00	0.00	0.00	0.00	0.00	0.00	0.00	0.00	0.00	0.00

Luminaire

Code 10-7982-14-14
Name SIMPLY

Measurement

Code 10-7982-14-14
Name SIMPLY

Luminaire Flux	317 lm	Luminaire Power	4.3 W	Efficacy	73.826 lm/W	Efficiency	90.70%
Source Flux	350 lm	Maximum value	2277.95 cd/klm	Position	C=0.00 G=0.00	CG	Rotosymmetrical

US ROAD STANDARDS

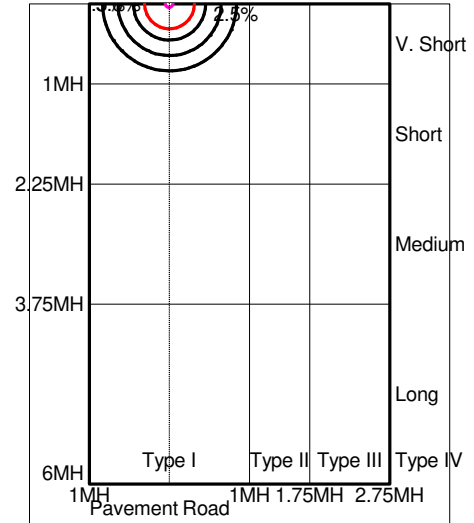
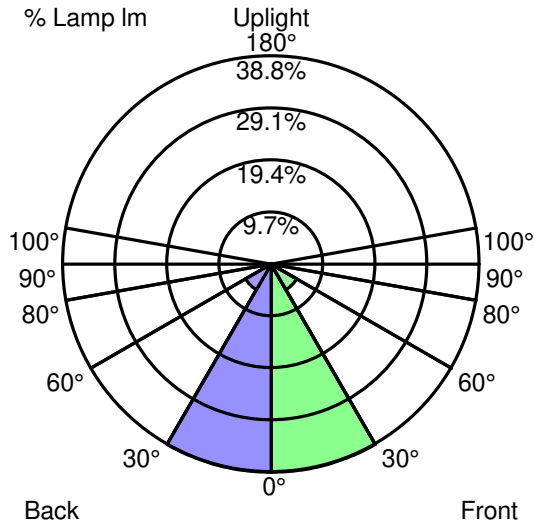

Luminaire Classification System (LCS)

LCS Zone		Lumens	%Lamp	%Lum
FL	0° -- 30°	135.9 lm	38.8 %	42.8 %
FM	30° -- 60°	19.2 lm	5.5 %	6.1 %
FH	60° -- 80°	3.2 lm	0.9 %	1.0 %
FVH	80° -- 90°	0.4 lm	0.1 %	0.1 %
BL	0° -- 30°	135.9 lm	38.8 %	42.8 %
BM	30° -- 60°	19.2 lm	5.5 %	6.1 %
BH	60° -- 80°	3.2 lm	0.9 %	1.0 %
BVH	80° -- 90°	0.4 lm	0.1 %	0.1 %
UL	90° -- 100°	0.0 lm	0.0 %	0.0 %
UH	100° -- 180°	0.0 lm	0.0 %	0.0 %
TOTALS		317.4 lm	90.7 %	100.0 %
BUG B1 U0 G0		Type V Very Short	Quadrilateral Symmetry	



SIMPLY

TABLE

