



## Organic

Manel Llusçà

Sobremesa Organic E27 15W Negro 771lm

### Características técnicas

Potencia total luminaria: 15W

Ángulo Ópticas / Reflector: HORIZONTAL 117°

Material de la estructura: Acero

Acabado estructura: Negro

Medida máx. de la bombilla: 120/80 mm

Bombilla recomendada: E27

Voltaje / Frecuencia: 100-240V ~ 50/60Hz

Garantía: 5 años

Luminaria fácilmente reciclable

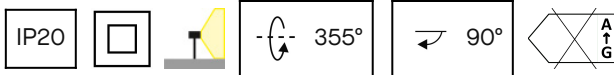

### Características luminotécnicas

Portalámparas	Cantidad	Potencia fuente de luz (W)	Temperatura de color correlacionada (CCT)
E27	1	Potencia máx. 15W	-

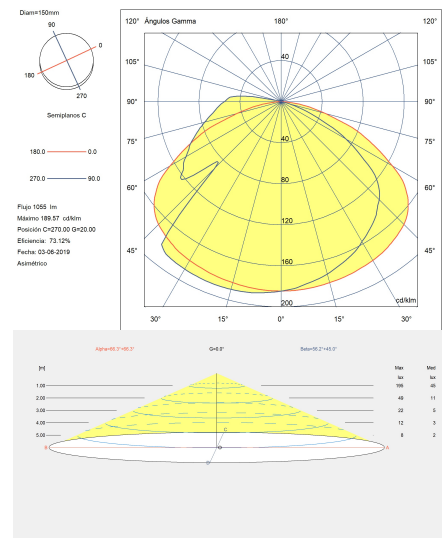
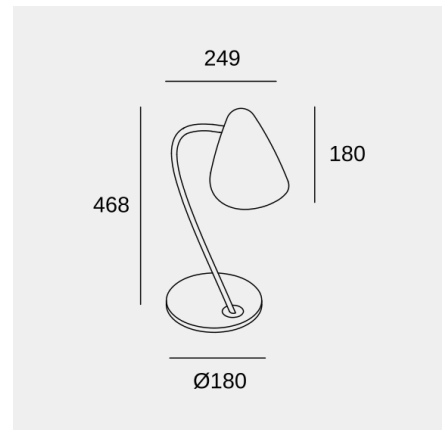

Fotometría realizada con una bombilla estándar

La imagen puede no coincidir con la referencia, LedsC4 se reserva el derecho de modificación de alguno de los componentes que componen el producto. Los datos relativos al flujo, la potencia y la temperatura de color pueden estar sujetos a cambios del fabricante.



## Organic

Manel Llusçà

Sobremesa Organic E27 15W Negro 771lm

### Logística



x 2

Peso neto (Kg): 2.6

Peso embalado (Kg): 4

Embalaje: 345mm x 200mm x 520mm

### Aplicación de la luminaria



La imagen puede no coincidir con la referencia, LedsC4 se reserva el derecho de modificación de alguno de los componentes que componen el producto. Los datos relativos al flujo, la potencia y la temperatura de color pueden estar sujetos a cambios del fabricante.

## Luminaire

Code 10-7582-05-05  
Name ORGANIC

## Measurement

Code 10-7582-05-05  
Name ORGANIC

Luminaire Flux	771 lm	Luminaire Power	10.9 W	Efficacy	70.775 lm/W	Efficiency	73.12%
Source Flux	1055 lm	Maximum value	189.57 cd/klm	Position	C=270.00 G=20.00	CG	Asymmetrical
Round Luminaire		Diam.	150 mm	Height	200 mm		
Round Luminous Area		Diam.	60 mm	Height	60 mm		
Horizontal Luminous Area			0.002827 m2	Emitting area on Plane 180°			0.003600 m2
Emitting area on Plane 0°			0.003600 m2	Emitting area on Plane 270°			0.003600 m2
Emitting area on Plane 90°			0.003600 m2	Glare area at 76°			0.004177 m2
Coordinate system		CG		Symmetry Type		Asymmetrical	
Date		03-06-2019		Maximum Gamma Angle		180	
Measurement Distance		0.00		Measurement Flux		1055 lm	
Operator		qualitat		Rated Voltage			
Temperature				Rated Current			
Humidity				Photocell			
Notes							

## Luminaire Sources

Line	Code LED	Name	Flux [lm]	Pow. [W]	Q.ty
		-	1055.00	10.90	1
C.I.E.	40 73 92 95 73	D DIN 5040	A21		
F UTE	0.70 G + 0.03 T	B NBN	BZ 5		

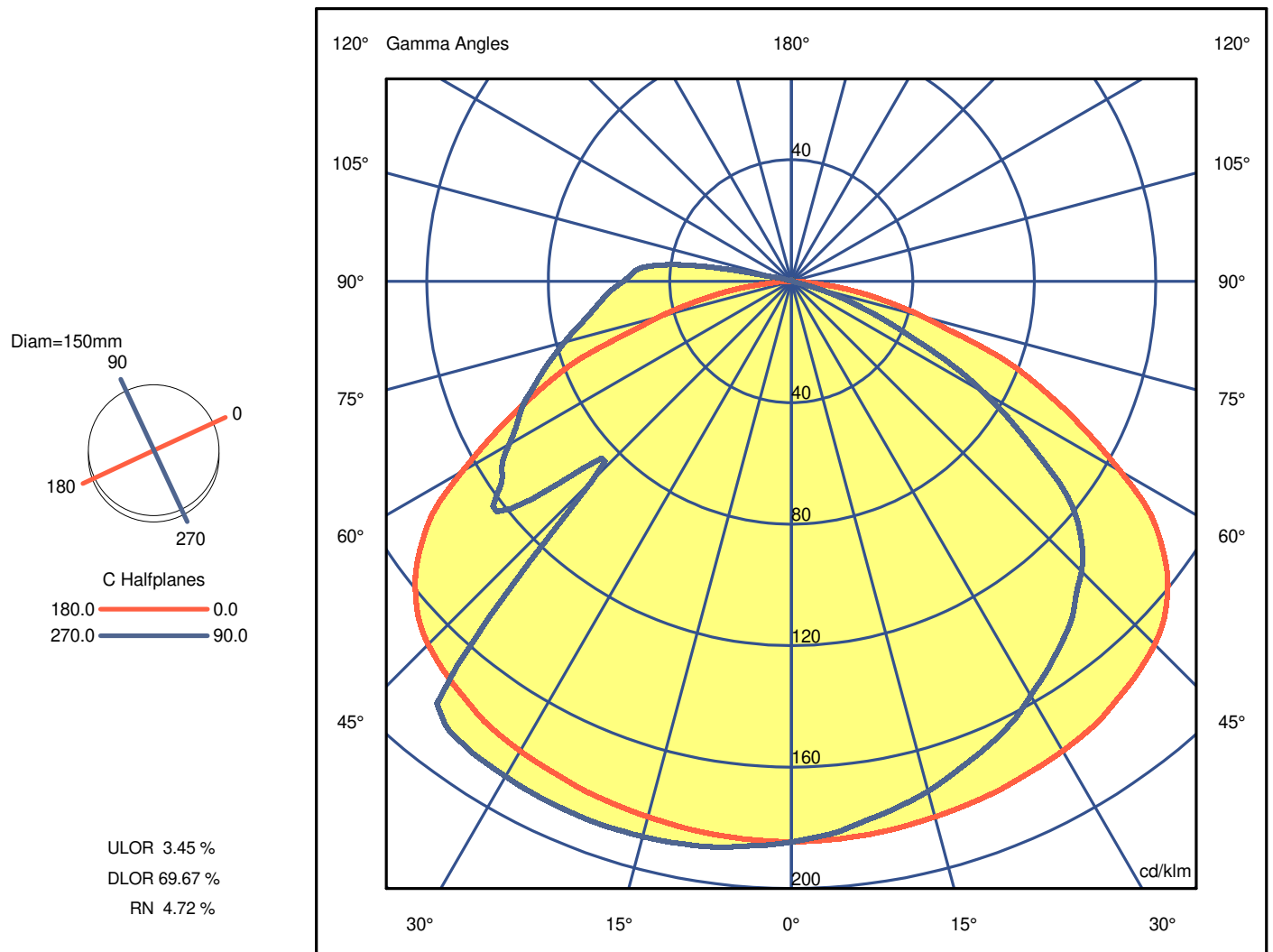

**Luminaire**

 Code 10-7582-05-05  
 Name ORGANIC

**Measurement**

 Code 10-7582-05-05  
 Name ORGANIC

Luminaire Flux	771 lm	Luminaire Power	10.9 W	Efficacy	70.775 lm/W	Efficiency	73.12%
Source Flux	1055 lm	Maximum value	189.57 cd/klm	Position	C=270.00 G=20.00	CG	Asymmetrical

**Luminous Intensity Table cd/klm Table 1/2**

	C 0.00	C 15.00	C 30.00	C 45.00	C 60.00	C 75.00	C 90.00	C 105.00	C 120.00	C 135.00	C 150.00	C 165.00	C 180.00
G 0.0	184.60	184.60	184.60	184.60	184.60	184.60	184.60	184.60	184.60	184.60	184.60	184.60	184.60
G 2.5	184.46	184.22	183.88	183.62	183.37	183.37	183.27	183.37	183.37	183.62	183.88	184.22	184.46
G 5.0	184.25	183.72	183.01	182.53	182.04	181.78	181.80	181.78	182.04	182.53	183.01	183.72	184.25
G 7.5	183.97	183.17	182.10	181.19	180.50	180.18	179.51	180.18	180.50	181.19	182.10	183.17	183.97
G 10.0	183.65	182.59	180.68	179.96	178.77	178.47	177.75	178.47	178.77	179.96	180.68	182.59	183.65
G 12.5	183.09	181.61	179.62	178.59	176.84	176.75	175.86	176.75	176.84	178.59	179.62	181.61	183.09
G 15.0	182.59	180.75	178.47	176.93	175.13	174.95	173.88	174.95	175.13	176.93	178.47	180.75	182.59
G 17.5	182.04	179.89	177.31	175.52	173.34	172.76	171.35	172.76	173.34	175.52	177.31	179.89	182.04
G 20.0	181.49	178.98	176.02	173.71	171.10	170.29	168.85	170.29	171.10	173.71	176.02	178.98	181.49
G 22.5	180.89	177.98	174.10	171.99	168.98	168.15	166.60	168.15	168.98	171.99	174.10	177.98	180.89
G 25.0	179.98	176.95	172.63	170.21	166.35	165.82	164.07	165.82	166.35	170.21	172.63	176.95	179.98
G 27.5	179.34	175.70	171.04	167.92	163.92	163.24	161.25	163.24	163.92	167.92	171.04	175.70	179.34
G 30.0	178.58	174.57	169.36	165.86	161.34	160.21	157.47	160.21	161.34	165.86	169.36	174.57	178.58
G 32.5	177.68	173.35	167.50	163.28	158.06	156.88	154.35	156.88	158.06	163.28	167.50	173.35	177.68
G 35.0	176.67	171.75	164.82	160.78	155.23	153.85	150.98	153.85	155.23	160.78	164.82	171.75	176.67
G 37.5	174.83	170.06	162.60	158.17	151.45	150.61	147.65	150.61	151.45	158.17	162.60	170.06	174.83
G 40.0	173.21	167.97	160.07	154.99	148.11	146.91	143.99	146.91	148.11	154.99	160.07	167.97	173.21
G 42.5	171.30	165.78	157.34	151.65	144.64	142.70	138.99	142.70	144.64	151.65	157.34	165.78	171.30
G 45.0	169.09	163.29	153.06	148.22	139.91	138.63	135.07	138.63	139.91	148.22	153.06	163.29	169.09
G 47.5	166.06	159.75	147.25	143.93	134.20	134.49	129.98	134.49	134.20	143.93	147.25	159.75	166.06
G 50.0	161.51	153.83	139.24	136.72	125.58	129.03	122.87	129.03	125.58	136.72	139.24	153.83	161.51
G 52.5	155.83	146.60	129.46	127.87	115.31	119.90	113.35	119.90	115.31	127.87	129.46	146.60	155.83
G 55.0	148.12	137.39	117.70	115.02	102.43	108.28	98.67	108.28	102.43	115.02	117.70	137.39	148.12
G 57.5	138.89	126.43	101.95	102.78	88.47	96.37	85.83	96.37	88.47	102.78	101.95	126.43	138.89
G 60.0	125.08	112.50	87.54	89.34	73.12	83.49	73.14	83.49	73.12	89.34	87.54	112.50	125.08
G 62.5	111.83	97.14	73.77	74.24	60.63	71.10	59.81	71.10	60.63	74.24	73.77	97.14	111.83
G 65.0	98.86	83.98	60.41	60.93	48.36	56.00	44.22	56.00	48.36	60.93	60.41	83.98	98.86
G 67.5	86.21	70.63	47.70	46.54	36.21	42.11	32.76	42.11	36.21	46.54	47.70	70.63	86.21
G 70.0	73.43	57.48	31.81	35.28	24.97	31.51	23.06	31.51	24.97	35.28	31.81	57.48	73.43
G 72.5	56.28	42.34	21.47	24.85	14.68	21.77	15.08	21.77	14.68	24.85	21.47	42.34	56.28
G 75.0	45.02	29.98	12.94	14.49	7.73	13.21	8.09	13.21	7.73	14.49	12.94	29.98	45.02
G 77.5	34.52	20.12	6.38	7.10	2.66	6.13	1.95	6.13	2.66	7.10	6.38	20.12	34.52
G 80.0	25.19	12.33	2.40	1.76	0.53	1.46	0.44	1.46	0.53	1.76	2.40	12.33	25.19
G 82.5	16.64	5.14	0.69	0.59	0.48	0.48	0.38	0.48	0.48	0.59	0.69	5.14	16.64
G 85.0	8.32	2.00	0.53	0.48	0.48	0.44	0.38	0.44	0.48	0.48	0.53	2.00	8.32
G 87.5	3.49	0.67	0.51	0.46	0.50	0.40	0.38	0.40	0.50	0.46	0.51	0.67	3.49
G 90.0	1.05	0.55	0.51	0.46	0.50	0.38	0.38	0.38	0.50	0.46	0.51	0.55	1.05
G 92.5	0.62	0.55	0.50	0.46	0.49	0.37	0.38	0.37	0.49	0.46	0.50	0.55	0.62
G 95.0	0.58	0.52	0.51	0.46	0.48	0.38	0.38	0.38	0.48	0.46	0.51	0.52	0.58
G 97.5	0.55	0.52	0.53	0.46	0.47	0.40	0.38	0.40	0.47	0.46	0.53	0.52	0.55
G100.0	0.52	0.55	0.55	0.46	0.47	0.40	0.38	0.40	0.47	0.46	0.55	0.55	0.52
G102.5	0.52	0.53	0.55	0.42	0.45	0.39	0.38	0.39	0.45	0.42	0.55	0.53	0.52
G105.0	0.52	0.55	0.55	0.42	0.44	0.40	0.38	0.40	0.44	0.42	0.55	0.55	0.52
G107.5	0.52	0.52	0.52	0.41	0.42	0.41	0.42	0.41	0.42	0.41	0.52	0.52	0.52
G110.0	0.52	0.52	0.53	0.44	0.44	0.42	0.38	0.42	0.44	0.44	0.53	0.52	0.52
G112.5	0.50	0.50	0.51	0.46	0.46	0.45	0.39	0.45	0.46	0.46	0.51	0.50	0.50
G115.0	0.50	0.50	0.51	0.50	0.49	0.47	0.42	0.47	0.49	0.50	0.51	0.50	0.50
G117.5	0.48	0.50	0.50	0.50	0.52	0.48	0.42	0.48	0.52	0.50	0.50	0.50	0.48
G120.0	0.48	0.50	0.48	0.49	0.51	0.51	0.42	0.51	0.51	0.49	0.48	0.50	0.48
G122.5	0.48	0.50	0.50	0.50	0.50	0.52	0.42	0.52	0.50	0.50	0.50	0.50	0.48
G125.0	0.49	0.50	0.48	0.50	0.51	0.49	0.42	0.49	0.51	0.50	0.48	0.50	0.49
G127.5	0.50	0.50	0.48	0.48	0.49	0.47	0.42	0.47	0.49	0.48	0.48	0.50	0.50
G130.0	0.48	0.50	0.48	0.48	0.49	0.45	0.42	0.45	0.49	0.48	0.48	0.50	0.48
G132.5	0.48	0.50	0.48	0.48	0.47	0.44	0.42	0.44	0.47	0.48	0.48	0.50	0.48
G135.0	0.48	0.50	0.48	0.46	0.47	0.44	0.42	0.44	0.47	0.46	0.48	0.50	0.48
G137.5	0.48	0.50	0.48	0.45	0.47	0.45	0.42	0.45	0.47	0.45	0.48	0.50	0.48
G140.0	0.52	0.50	0.48	0.46	0.45	0.46	0.46	0.46	0.45	0.46	0.48	0.50	0.52
G142.5	0.52	0.50	0.47	0.46	0.44	0.46	0.47	0.46	0.44	0.46	0.47	0.50	0.52
G145.0	0.49	0.52	0.48	0.46	0.46	0.46	0.47	0.46	0.46	0.46	0.48	0.52	0.49
G147.5	0.52	0.50	0.48	0.46	0.48	0.45	0.47	0.45	0.48	0.46	0.48	0.50	0.52
G150.0	0.52	0.50	0.48	0.46	0.48	0.46	0.47	0.46	0.48	0.46	0.48	0.50	0.52
G152.5	0.52	0.52	0.48	0.47	0.47	0.46	0.47	0.46	0.47	0.47	0.48	0.52	0.52
G155.0	0.52	0.51	0.48	0.48	0.47	0.46	0.47	0.46	0.47	0.48	0.48	0.51	0.52
G157.5	0.54	0.52	0.48	0.46	0.47	0.46	0.47	0.46	0.47	0.46	0.48	0.52	0.54
G160.0	0.54	0.52	0.48	0.46	0.47	0.46	0.47	0.46	0.47	0.46	0.48	0.52	0.54
G162.5	0.52	0.51	0.48	0.46	0.48	0.48	0.51	0.48	0.48	0.46	0.48	0.51	0.52
G165.0	0.50	0.51	0.51	0.48	0.49	0.48	0.51	0.48	0.49	0.48	0.51	0.51	0.50
G167.5	0.50	0.52	0.52	0.50	0.51	0.51	0.51	0.51	0.51	0.50	0.52	0.52	0.50
G170.0	0.50	0.52	0.53	0.50	0.51	0.51	0.51	0.51	0.51	0.50	0.53	0.52	0.50
G172.5	0.50	0.52	0.53	0.50	0.51	0.53	0.53	0.53	0.51	0.50	0.53	0.52	0.50
G175.0	0.50	0.52	0.53	0.50	0.53	0.53	0.55	0.53	0.53	0.50	0.53	0.52	0.50
G177.5	0.50	0.55	0.51	0.53	0.51	0.53	0.55	0.53	0.51	0.53	0.51	0.55	0.50
G180.0	0.53	0.53	0.53	0.53	0.53	0.53	0.53	0.53	0.53	0.53	0.53	0.53	0.53

**Luminaire**

Code 10-7582-05-05

Name ORGANIC

**Measurment.**

Code 10-7582-05-05

Name ORGANIC

Luminaire Flux	771 lm	Luminaire Power	10.9 W	Efficacy	70.775 lm/W	Efficiency	73.12%
Source Flux	1055 lm	Maximum value	189.57 cd/klm	Position	C=270.00 G=20.00	CG	Asymmetrical

**Luminous Intensity Table cd/klm Table 2/2**

	C 195.00	C 210.00	C 225.00	C 240.00	C 255.00	C 270.00	C 285.00	C 300.00	C 315.00	C 330.00	C 345.00
G 0.0	184.60	184.60	184.60	184.60	184.60	184.60	184.60	184.60	184.60	184.60	184.60
G 2.5	184.85	185.33	185.36	185.79	185.60	185.80	185.60	185.79	185.36	185.33	184.85
G 5.0	184.96	185.78	185.97	186.83	186.63	186.77	186.63	186.83	185.97	185.78	184.96
G 7.5	184.98	186.11	186.47	187.52	187.29	187.97	187.29	187.52	186.47	186.11	184.98
G 10.0	184.87	186.36	186.85	188.06	187.86	188.50	187.86	188.06	186.85	186.36	184.87
G 12.5	184.64	186.45	186.99	188.53	188.22	189.01	188.22	188.53	186.99	186.45	184.64
G 15.0	184.31	186.44	187.06	188.70	188.34	189.29	188.34	188.70	187.06	186.44	184.31
G 17.5	184.03	186.36	187.02	188.88	188.44	189.46	188.44	188.88	187.02	186.36	184.03
G 20.0	183.73	186.19	186.89	188.83	188.30	189.57	188.30	188.83	186.89	186.19	183.73
G 22.5	183.25	185.99	186.69	188.70	188.15	189.38	188.15	188.70	186.69	185.99	183.25
G 25.0	182.76	185.73	186.43	188.48	187.82	189.11	187.82	188.48	186.43	185.73	182.76
G 27.5	182.25	185.21	186.03	188.19	187.45	188.78	187.45	188.19	186.03	185.21	182.25
G 30.0	181.66	184.81	185.42	187.71	186.89	188.30	186.89	187.71	185.42	184.81	181.66
G 32.5	180.96	184.21	184.75	187.16	186.16	187.74	186.16	187.16	184.75	184.21	180.96
G 35.0	179.82	183.51	183.80	186.50	185.37	187.01	185.37	186.50	183.80	183.51	179.82
G 37.5	178.48	182.62	182.70	185.46	184.33	186.11	184.33	185.46	182.70	182.62	178.48
G 40.0	177.00	181.13	181.35	184.28	183.09	181.57	183.09	184.28	181.35	181.13	177.00
G 42.5	175.25	179.62	179.44	182.74	181.15	137.33	181.15	182.74	179.44	179.62	175.25
G 45.0	173.06	177.83	177.20	181.07	178.59	92.38	178.59	181.07	177.20	177.83	173.06
G 47.5	170.21	175.63	174.70	178.99	176.21	87.77	176.21	178.99	174.70	175.63	170.21
G 50.0	166.49	173.08	171.87	176.35	173.57	111.55	173.57	176.35	171.87	173.08	166.49
G 52.5	162.32	169.13	168.70	173.15	170.50	123.57	170.50	173.15	168.70	169.13	162.32
G 55.0	156.38	165.54	164.43	169.78	167.13	116.69	167.13	169.78	164.43	165.54	156.38
G 57.5	148.45	161.10	159.54	166.05	162.54	113.11	162.54	166.05	159.54	161.10	148.45
G 60.0	138.31	155.49	154.45	161.23	158.06	107.33	158.06	161.23	154.45	155.49	138.31
G 62.5	125.63	146.44	148.69	156.32	152.99	101.85	152.99	146.44	148.69	146.44	125.63
G 65.0	114.27	137.66	140.99	150.18	146.64	97.80	146.64	150.18	140.99	137.66	114.27
G 67.5	102.15	128.02	133.39	144.54	140.39	92.21	140.39	144.54	133.39	128.02	102.15
G 70.0	88.78	117.57	123.29	138.30	133.66	87.22	133.66	138.30	123.29	117.57	88.78
G 72.5	75.06	106.94	114.08	130.20	127.47	82.22	127.47	130.20	114.08	106.94	75.06
G 75.0	62.44	91.77	104.49	123.26	121.10	77.28	121.10	123.26	104.49	91.77	62.44
G 77.5	52.15	81.28	93.49	114.29	113.86	72.94	113.86	114.29	93.49	81.28	52.15
G 80.0	42.25	70.83	84.23	106.38	106.58	68.36	106.58	106.38	84.23	70.83	42.25
G 82.5	31.98	60.98	73.75	98.71	100.49	65.06	100.49	98.71	73.75	60.98	31.98
G 85.0	23.52	52.27	65.19	89.48	94.04	62.00	94.04	89.48	65.19	52.27	23.52
G 87.5	16.84	41.09	57.22	81.37	87.46	58.99	87.46	81.37	57.22	41.09	16.84
G 90.0	11.28	33.70	48.30	73.05	80.41	55.40	80.41	73.05	48.30	33.70	11.28
G 92.5	6.96	26.92	41.35	65.94	72.99	52.72	72.99	65.94	41.35	26.92	6.96
G 95.0	3.23	20.92	33.85	58.12	67.24	49.92	67.24	58.12	33.85	20.92	3.23
G 97.5	1.68	15.18	28.03	51.51	61.31	41.90	61.31	51.51	28.03	15.18	1.68
G100.0	0.92	9.97	22.85	44.51	55.21	27.56	55.21	44.51	22.85	9.97	0.92
G102.5	0.80	6.42	17.50	38.78	47.37	8.78	47.37	38.78	17.50	6.42	0.80
G105.0	0.72	3.77	12.59	33.68	38.73	4.60	38.73	33.68	12.59	3.77	0.72
G107.5	0.66	2.02	9.19	28.51	34.62	2.84	34.62	28.51	9.19	2.02	0.66
G110.0	0.62	0.99	6.20	24.16	31.90	0.88	31.90	24.16	6.20	0.99	0.62
G112.5	0.60	0.83	3.69	19.58	27.47	0.51	27.47	19.58	3.69	0.83	0.60
G115.0	0.59	0.77	1.88	16.19	20.81	0.43	20.81	16.19	1.88	0.77	0.59
G117.5	0.58	0.70	0.83	12.97	13.69	0.36	13.69	12.97	0.83	0.70	0.58
G120.0	0.55	0.65	0.64	9.62	10.12	0.34	10.12	9.62	0.64	0.65	0.55
G122.5	0.53	0.59	0.59	7.25	8.09	0.34	8.09	7.25	0.59	0.59	0.53
G125.0	0.52	0.59	0.59	4.82	6.09	0.34	6.09	4.82	0.59	0.59	0.52
G127.5	0.52	0.59	0.59	3.29	4.81	0.38	4.81	3.29	0.59	0.59	0.52
G130.0	0.52	0.59	0.56	2.15	3.77	0.38	3.77	2.15	0.56	0.59	0.52
G132.5	0.52	0.59	0.56	1.31	3.18	0.38	3.18	1.31	0.56	0.59	0.52
G135.0	0.52	0.57	0.59	0.84	2.46	0.39	2.46	0.84	0.59	0.57	0.52
G137.5	0.52	0.54	0.59	0.60	1.83	0.42	1.83	0.60	0.59	0.54	0.52
G140.0	0.52	0.55	0.59	0.56	1.04	0.42	1.04	0.56	0.59	0.55	0.52
G142.5	0.52	0.54	0.59	0.59	0.58	0.42	0.58	0.59	0.59	0.54	0.52
G145.0	0.52	0.55	0.59	0.59	0.47	0.42	0.47	0.59	0.59	0.55	0.52
G147.5	0.52	0.55	0.57	0.58	0.46	0.43	0.46	0.58	0.57	0.55	0.52
G150.0	0.52	0.57	0.60	0.59	0.46	0.47	0.46	0.59	0.60	0.57	0.52
G152.5	0.53	0.57	0.61	0.59	0.46	0.47	0.46	0.59	0.61	0.57	0.53
G155.0	0.57	0.59	0.61	0.57	0.48	0.47	0.48	0.57	0.61	0.59	0.57
G157.5	0.55	0.61	0.61	0.56	0.48	0.47	0.48	0.56	0.61	0.61	0.55
G160.0	0.55	0.61	0.59	0.53	0.51	0.51	0.51	0.53	0.59	0.61	0.55
G162.5	0.57	0.61	0.59	0.53	0.51	0.51	0.51	0.53	0.59	0.61	0.57
G165.0	0.57	0.61	0.55	0.53	0.52	0.51	0.52	0.53	0.55	0.61	0.57
G167.5	0.53	0.59	0.55	0.52	0.52	0.54	0.52	0.52	0.55	0.59	0.53
G170.0	0.52	0.57	0.53	0.54	0.52	0.55	0.52	0.54	0.53	0.57	0.52
G172.5	0.52	0.55	0.54	0.55	0.51	0.55	0.51	0.55	0.54	0.55	0.52
G175.0	0.52	0.53	0.55	0.55	0.53	0.55	0.53	0.55	0.55	0.53	0.52
G177.5	0.52	0.55	0.54	0.55	0.53	0.55	0.53	0.55	0.54	0.55	0.52
G180.0	0.53	0.53	0.53	0.53	0.53	0.53	0.53	0.53	0.53	0.53	0.53

# LedsC4

**Luminaire**

Code 10-7582-05-05  
Name ORGANIC

**Measur.**

Code 10-7582-05-05  
Name ORGANIC

Luminaire Flux	771 lm	Luminaire Power	10.9 W	Efficacy	70.775 lm/W	Efficiency	73.12%
Source Flux	1055 lm	Maximum value	189.57 cd/klm	Position	C=270.00 G=20.00	CG	Asymmetrical

Diam=150mm

C Halfplanes

180.0 ———— 0.0  
270.0 ———— 90.0

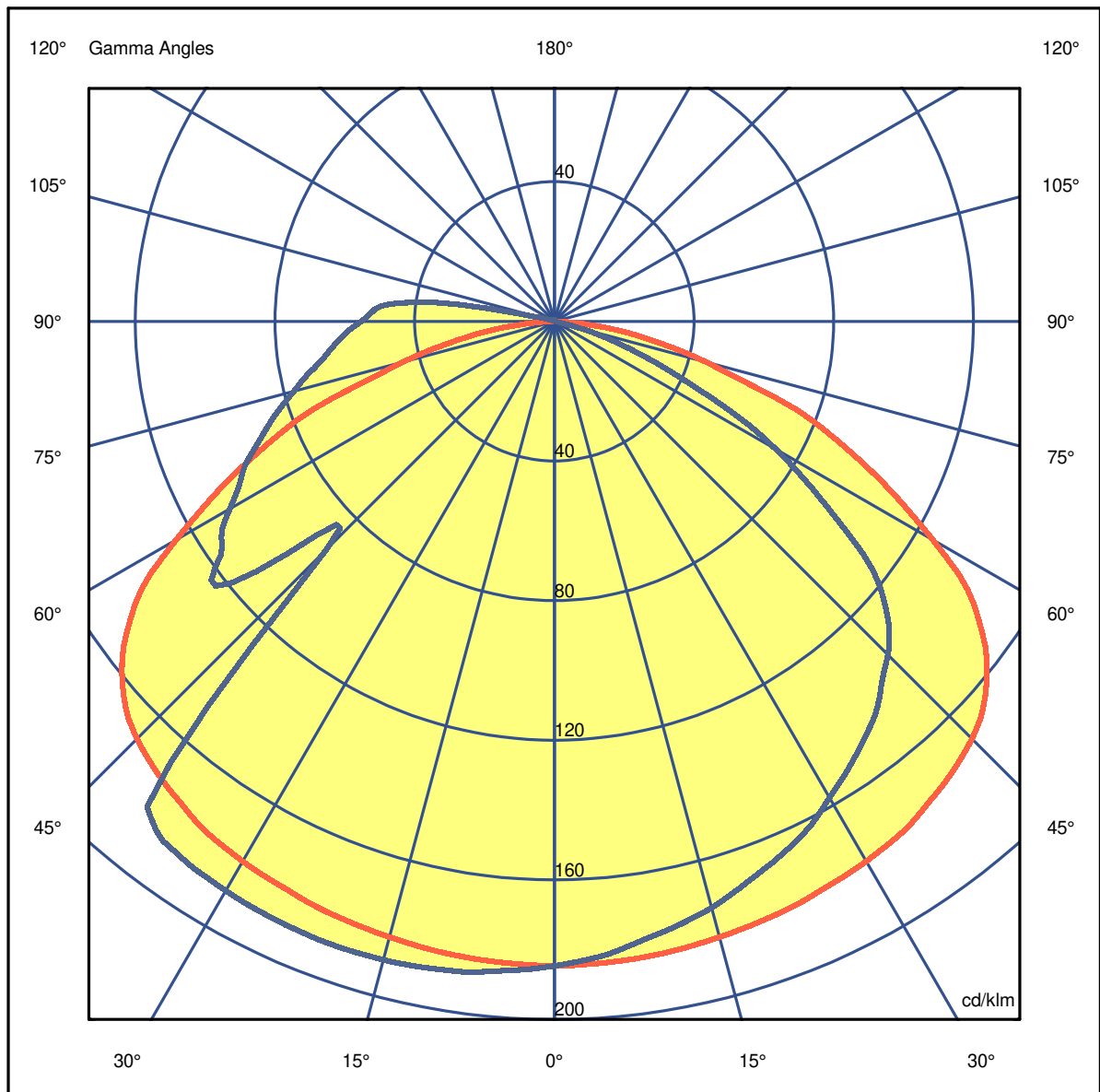
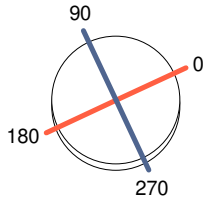

# LedsC4

## Luminaire

Code 10-7582-05-05  
Name ORGANIC

## Measurement

Code 10-7582-05-05  
Name ORGANIC

Luminaire Flux	771 lm	Luminaire Power	10.9 W	Efficacy	70.775 lm/W	Efficiency	73.12%
Source Flux	1055 lm	Maximum value	189.57 cd/klm	Position	C=270.00 G=20.00	CG	Asymmetrical

Diam=150mm

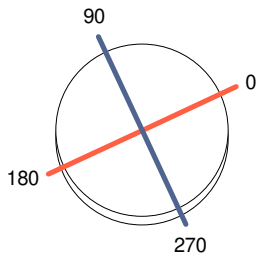

C Halfplanes



**Luminaire**

Code 10-7582-05-05  
Name ORGANIC

**Measurem.**

Code 10-7582-05-05  
Name ORGANIC

Luminaire Flux	771 lm	Luminaire Power	10.9 W	Efficacy	70.775 lm/W	Efficiency	73.12%
Source Flux	1055 lm	Maximum value	189.57 cd/klm	Position	C=270.00 G=20.00	CG	Asymmetrical

**UGR**  
S = 0.250

Reflectancies										
Ceiling/Cavity	0.7	0.7	0.5	0.5	0.3	0.7	0.7	0.5	0.5	0.3
Walls	0.5	0.3	0.5	0.3	0.3	0.5	0.3	0.5	0.3	0.3
Working Plane	0.2	0.2	0.2	0.2	0.2	0.2	0.2	0.2	0.2	0.2
Room Dimensions	Lateral View					Viewed Endwise				
x=2H y=2H	24.9	26.2	25.2	26.6	26.9	25.7	27.1	26.0	27.4	27.7
x=2H y=3H	25.9	27.2	26.4	27.5	27.9	27.5	28.7	27.9	29.1	29.5
x=2H y=4H	26.2	27.4	26.6	27.7	28.2	28.2	29.4	28.6	29.8	30.2
x=2H y=6H	26.3	27.4	26.8	27.8	28.2	28.8	29.9	29.3	30.3	30.8
x=2H y=8H	26.3	27.4	26.8	27.8	28.2	29.1	30.1	29.5	30.5	31.0
x=2H y=12H	26.3	27.3	26.7	27.7	28.2	29.3	30.4	29.8	30.8	31.2
x=4H y=2H	25.5	26.6	25.9	27.0	27.4	26.5	27.7	26.9	28.1	28.5
x=4H y=3H	26.8	27.8	27.2	28.2	28.7	28.7	29.7	29.1	30.1	30.5
x=4H y=4H	27.2	28.1	27.7	28.5	29.0	29.7	30.6	30.2	31.1	31.5
x=4H y=6H	27.4	28.2	27.9	28.7	29.2	30.6	31.4	31.1	31.9	32.4
x=4H y=8H	27.4	28.2	27.9	28.6	29.2	31.0	31.8	31.5	32.2	32.8
x=4H y=12H	27.4	28.1	27.9	28.6	29.1	31.3	32.0	31.8	32.5	33.0
x=8H y=4H	27.6	28.3	28.1	28.8	29.3	30.1	30.8	30.6	31.3	31.8
x=8H y=6H	28.0	28.6	28.5	29.1	29.7	31.3	31.9	31.9	32.4	33.0
x=8H y=8H	28.1	28.7	28.7	29.2	29.8	31.9	32.5	32.5	33.0	33.6
x=8H y=12H	28.1	28.6	28.7	29.2	29.8	32.5	33.0	33.1	33.5	34.1
x=12H y=4H	27.7	28.3	28.2	28.8	29.4	30.1	30.8	30.6	31.3	31.8
x=12H y=6H	28.1	28.7	28.7	29.2	29.8	31.4	32.0	32.0	32.5	33.1
x=12H y=8H	28.3	28.8	28.9	29.3	30.0	32.1	32.6	32.7	33.1	33.7

## Luminaire

Code 10-7582-05-05  
Name ORGANIC

## Measurerm.

Code 10-7582-05-05  
Name ORGANIC

Luminaire Flux	771 lm	Luminaire Power	10.9 W	Efficacy	70.775 lm/W	Efficiency	73.12%
Source Flux	1055 lm	Maximum value	189.57 cd/klm	Position	C=270.00 G=20.00	CG	Asymmetrical

Total Flux=1055.00 Luminaire Flux=771.45

RI	0.60	0.80	1.00	1.25	1.50	2.00	2.50	3.00	4.00	5.00	10.00	20.00
DRR	0.25	0.33	0.41	0.48	0.54	0.63	0.69	0.73	0.78	0.82	0.90	0.94
RC	6	6	6	6	6	6	6	6	6	6	6	6

Zonal Flux per 1000 Lumen

Y°	10	20	30	40	50	60	70	80	90	100	110	120	130	140	150	160	170	180
ZF(Y)	18	69	152	260	383	506	603	663	697	716	725	729	730	730	731	731	731	731

CIE Flux Codes

40 73 92 95 73

C.I.E.	6	LOR	73.12275 %
D DIN 5040	A21	ULOR	3.45036 %
F UTE	0.70 G + 0.03 T	DLOR	69.67239 %
B NBN	BZ 5	UFF	4.71859 %
RN	4.71859 %	DFF	95.28141 %
BLF	1.0	FFR	4.95227 %

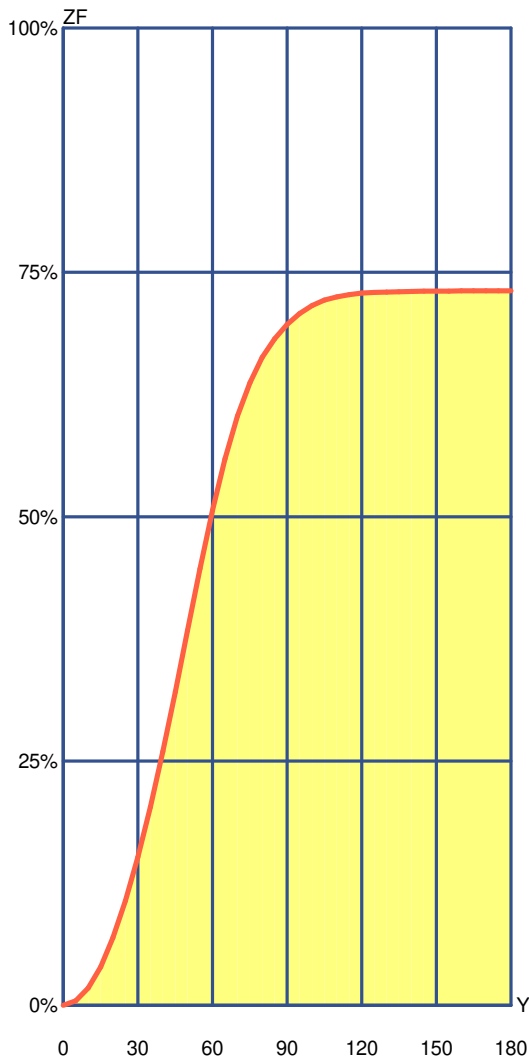

Gamma °	Zonal Flux			
	Flux	Sum lm	Flux [%]	Sum [%]
0°	0.00	0.00	0.00%	0.00 %
5°	4.41	4.41	0.60%	0.60 %
10°	13.16	17.57	1.80%	2.40 %
15°	21.68	39.25	2.97%	5.37 %
20°	29.88	69.12	4.09%	9.45 %
25°	37.62	106.75	5.14%	14.60 %
30°	44.81	151.56	6.13%	20.73 %
35°	51.30	202.86	7.02%	27.74 %
40°	56.91	259.77	7.78%	35.53 %
45°	60.73	320.50	8.31%	43.83 %
50°	62.95	383.45	8.61%	52.44 %
55°	63.38	446.84	8.67%	61.11 %
60°	59.61	506.45	8.15%	69.26 %
65°	52.62	559.06	7.20%	76.46 %
70°	43.88	602.94	6.00%	82.46 %
75°	34.27	637.21	4.69%	87.14 %
80°	25.59	662.80	3.50%	90.64 %
85°	19.26	682.06	2.63%	93.28 %
90°	14.66	696.72	2.01%	95.28 %
95°	11.15	707.87	1.52%	96.81 %
100°	8.21	716.08	1.12%	97.93 %
105°	5.37	721.46	0.74%	98.66 %
110°	3.50	724.96	0.48%	99.14 %
115°	2.34	727.30	0.32%	99.46 %
120°	1.35	728.65	0.18%	99.65 %
125°	0.79	729.44	0.11%	99.76 %
130°	0.48	729.92	0.07%	99.82 %
135°	0.32	730.24	0.04%	99.87 %
140°	0.23	730.47	0.03%	99.90 %
145°	0.17	730.64	0.02%	99.92 %
150°	0.15	730.79	0.02%	99.94 %
155°	0.13	730.92	0.02%	99.96 %
160°	0.11	731.03	0.01%	99.97 %
165°	0.09	731.12	0.01%	99.98 %
170°	0.06	731.18	0.01%	99.99 %
175°	0.04	731.21	0.01%	100.00 %
180°	0.01	731.23	0.00%	100.00 %

**Luminaire**

Code 10-7582-05-05  
Name ORGANIC

**Measurement**

Code 10-7582-05-05  
Name ORGANIC

Luminaire Flux	771 lm	Luminaire Power	10.9 W	Efficacy	70.775 lm/W	Efficiency	73.12%
Source Flux	1055 lm	Maximum value	189.57 cd/klm	Position	C=270.00 G=20.00	CG	Asymmetrical

Utilizations CIE

Mounting	Direct	Normalization										Normalised										Suspension Ratid/3										Standard CIE Settings																																																																																																																																																																																																																																																																																							
Ceiling																																																																																																																																																																																																																																																																																																																							
K	8873	8773	8871	8771	7773	7771	7753	7553	7751	7551	7731	7331	7711	7111	5551	5531	5331	5511	5111	3331	3311	1111	0000	0.60	187	168	156	141	160	135	104	88	89	76	58	43	35	24	71	46	41	29	23	39	24	21	13	0.80	215	197	168	155	187	148	127	111	101	89	67	53	42	30	83	56	50	35	29	48	30	26	15	1.00	233	217	171	160	206	154	145	130	108	97	74	61	47	36	91	63	57	40	34	55	35	32	17	1.25	249	234	171	162	223	156	163	148	113	103	80	68	53	42	97	69	64	46	41	61	41	37	19	1.50	260	247	169	162	235	156	178	164	116	107	84	73	58	48	101	74	70	52	46	66	47	42	21	2.00	274	263	162	157	251	152	200	187	118	111	90	81	66	57	105	81	77	60	55	74	55	51	23	2.50	283	273	157	153	261	148	215	204	119	113	94	86	72	63	108	86	82	66	61	79	61	57	25	3.00	289	281	152	149	268	144	227	216	119	114	96	89	76	69	109	89	86	71	67	83	66	62	26	4.00	297	291	145	143	278	139	243	234	119	115	100	94	83	77	110	94	91	78	74	88	74	70	28	5.00	302	297	141	139	284	136	254	247	118	116	102	98	88	82	111	97	95	83	80	91	79	75	29	10.00	312	309	130	129	297	127	279	275	117	115	107	105	98	95	112	103	102	95	93	99	91	88	31	20.00	317	315	123	122	303	121	293	291	115	114	110	109	105	103	111	106	106	102	100	103	99	96	33

Wall

K	8873	8773	8871	8771	7773	7771	7753	7553	7751	7551	7731	7331	7711	7111	5551	5531	5331	5511	5111	3331	3311	1111	0000	0.60	354	344	315	307	338	303	266	259	245	239	205	200	177	173	236	200	198	174	172	197	172	171	157	0.80	402	391	348	341	383	335	312	303	280	274	240	234	210	205	269	234	232	207	204	230	204	203	186	1.00	435	425	368	362	415	356	346	337	304	298	265	259	235	230	292	258	256	231	229	253	228	226	207	1.25	465	455	385	379	443	372	378	369	325	319	289	282	260	254	313	281	278	255	252	275	251	248	227	1.50	488	478	396	391	464	384	403	394	341	336	307	300	279	273	328	298	296	273	270	291	269	265	242	2.00	514	506	406	402	490	395	436	427	359	354	329	323	303	297	345	319	317	297	293	311	291	287	261	2.50	532	525	412	409	507	401	460	451	370	366	344	338	321	315	357	334	331	313	310	325	307	302	274	3.00	544	538	416	413	519	406	476	468	378	375	354	349	333	328	365	344	342	326	322	335	319	313	283	4.00	566	561	426	424	540	416	504	497	394	391	374	369	356	351	380	363	361	347	344	353	339	332	300	5.00	583	578	435	433	557	425	526	519	406	404	389	385	373	369	393	378	376	364	361	367	355	347	314	10.00	629	626	463	463	602	455	583	579	444	443	433	431	423	420	430	421	420	412	410	410	402	392	356	20.00	664	663	489	489	638	482	627	625	475	474	469	467	462	461	462	456	456	451	450	444	440	429	391
---	------	------	------	------	------	------	------	------	------	------	------	------	------	------	------	------	------	------	------	------	------	------	------	------	-----	-----	-----	-----	-----	-----	-----	-----	-----	-----	-----	-----	-----	-----	-----	-----	-----	-----	-----	-----	-----	-----	-----	------	-----	-----	-----	-----	-----	-----	-----	-----	-----	-----	-----	-----	-----	-----	-----	-----	-----	-----	-----	-----	-----	-----	-----	------	-----	-----	-----	-----	-----	-----	-----	-----	-----	-----	-----	-----	-----	-----	-----	-----	-----	-----	-----	-----	-----	-----	-----	------	-----	-----	-----	-----	-----	-----	-----	-----	-----	-----	-----	-----	-----	-----	-----	-----	-----	-----	-----	-----	-----	-----	-----	------	-----	-----	-----	-----	-----	-----	-----	-----	-----	-----	-----	-----	-----	-----	-----	-----	-----	-----	-----	-----	-----	-----	-----	------	-----	-----	-----	-----	-----	-----	-----	-----	-----	-----	-----	-----	-----	-----	-----	-----	-----	-----	-----	-----	-----	-----	-----	------	-----	-----	-----	-----	-----	-----	-----	-----	-----	-----	-----	-----	-----	-----	-----	-----	-----	-----	-----	-----	-----	-----	-----	------	-----	-----	-----	-----	-----	-----	-----	-----	-----	-----	-----	-----	-----	-----	-----	-----	-----	-----	-----	-----	-----	-----	-----	------	-----	-----	-----	-----	-----	-----	-----	-----	-----	-----	-----	-----	-----	-----	-----	-----	-----	-----	-----	-----	-----	-----	-----	------	-----	-----	-----	-----	-----	-----	-----	-----	-----	-----	-----	-----	-----	-----	-----	-----	-----	-----	-----	-----	-----	-----	-----	-------	-----	-----	-----	-----	-----	-----	-----	-----	-----	-----	-----	-----	-----	-----	-----	-----	-----	-----	-----	-----	-----	-----	-----	-------	-----	-----	-----	-----	-----	-----	-----	-----	-----	-----	-----	-----	-----	-----	-----	-----	-----	-----	-----	-----	-----	-----	-----

Working Pl.

K	8873	8773	8871	8771	7773	7771	7753	7553	7751	7551	7731	7331	7711	7111	5551	5531	5331	5511	5111	3331	3311	1111	0000	0.60	396	385	370	361	379	356	291	284	280	274	230	224	193	189	270	224	222	190	188	220	188	187	173	0.80	476	464	439	430	454	422	365	356	348	341	296	289	256	251	335	288	285	252	249	283	249	247	232	1.00	538	526	491	482	513	473	426	416	403	396	351	343	310	304	387	341	338	305	302	334	301	297	283	1.25	598	585	539	531	569	521	487	475	456	448	406	397	365	358	438	394	391	358	355	385	353	349	334	1.50	642	630	574	567	611	555	533	521	495	488	448	439	409	401	476	435	431	400	396	424	394	388	374	2.00	707	696	623	617	673	605	605	593	554	548	512	503	476	468	533	497	494	466	461	484	457	450	436	2.50	749	740	654	649	714	636	653	642	593	587	555	547	522	514	570	538	535	510	506	524	500	491	478	3.00	779	771	675	671	743	658	688	677	620	614	586	578	556	548	597	568	565	543	538	553	531	521	508	4.00	817	810	701	698	780	685	734	725	654	649	625	619	600	592	630	606	604	585	581	590	571	559	547	5.00	841	835	717	715	803	701	764	755	675	671	650	645	628	621	651	631	628	612	608	613	597	583	571	10.00	893	889	750	749	853	736	830	825	720	718	706	702	692	687	696	684	683	672	670	664	654	637	626	20.00	921	919	768	767	881	754	868	865	746	745	738	736	730	727	722	715	714	708	707	694	688	669	658
---	------	------	------	------	------	------	------	------	------	------	------	------	------	------	------	------	------	------	------	------	------	------	------	------	-----	-----	-----	-----	-----	-----	-----	-----	-----	-----	-----	-----	-----	-----	-----	-----	-----	-----	-----	-----	-----	-----	-----	------	-----	-----	-----	-----	-----	-----	-----	-----	-----	-----	-----	-----	-----	-----	-----	-----	-----	-----	-----	-----	-----	-----	-----	------	-----	-----	-----	-----	-----	-----	-----	-----	-----	-----	-----	-----	-----	-----	-----	-----	-----	-----	-----	-----	-----	-----	-----	------	-----	-----	-----	-----	-----	-----	-----	-----	-----	-----	-----	-----	-----	-----	-----	-----	-----	-----	-----	-----	-----	-----	-----	------	-----	-----	-----	-----	-----	-----	-----	-----	-----	-----	-----	-----	-----	-----	-----	-----	-----	-----	-----	-----	-----	-----	-----	------	-----	-----	-----	-----	-----	-----	-----	-----	-----	-----	-----	-----	-----	-----	-----	-----	-----	-----	-----	-----	-----	-----	-----	------	-----	-----	-----	-----	-----	-----	-----	-----	-----	-----	-----	-----	-----	-----	-----	-----	-----	-----	-----	-----	-----	-----	-----	------	-----	-----	-----	-----	-----	-----	-----	-----	-----	-----	-----	-----	-----	-----	-----	-----	-----	-----	-----	-----	-----	-----	-----	------	-----	-----	-----	-----	-----	-----	-----	-----	-----	-----	-----	-----	-----	-----	-----	-----	-----	-----	-----	-----	-----	-----	-----	------	-----	-----	-----	-----	-----	-----	-----	-----	-----	-----	-----	-----	-----	-----	-----	-----	-----	-----	-----	-----	-----	-----	-----	-------	-----	-----	-----	-----	-----	-----	-----	-----	-----	-----	-----	-----	-----	-----	-----	-----	-----	-----	-----	-----	-----	-----	-----	-------	-----	-----	-----	-----	-----	-----	-----	-----	-----	-----	-----	-----	-----	-----	-----	-----	-----	-----	-----	-----	-----	-----	-----

LM53 SHR C0-C180: 1.453 SHR C90-C270: 1.274 SHR Square: 1.515

# LedsC4

## Luminaire

Code 10-7582-05-05  
Name ORGANIC

## Measurem.

Code 10-7582-05-05  
Name ORGANIC

Luminaire Flux	771 lm	Luminaire Power	10.9 W	Efficacy	70.775 lm/W	Efficiency	73.12%
Source Flux	1055 lm	Maximum value	189.57 cd/klm	Position	C=270.00 G=20.00	CG	Asymmetrical

Width at 50.00 % of Max Intensity

H[m]	1.00	2.00	3.00	4.00	5.00	H[m]	1.00	2.00	3.00	4.00	5.00
OA	2.28	4.55	6.83	9.10	11.38	OC	1.49	2.99	4.48	5.97	7.47
OB	2.28	4.55	6.83	9.10	11.38	OD	1.00	2.00	3.00	4.00	5.00

	Luminous Intensities [ cd/klm]									
	0	5	15	25	35	45	55	65	75	85
OA	194.76	194.39	192.63	189.88	186.39	178.39	156.27	104.30	47.50	8.78
OB	194.76	194.39	192.63	189.88	186.39	178.39	156.27	104.30	47.50	8.78
OC	194.76	191.79	183.45	173.09	159.29	142.49	104.10	46.65	8.54	0.40
OD	194.76	197.04	199.70	199.51	197.29	97.46	123.11	103.18	81.53	65.41

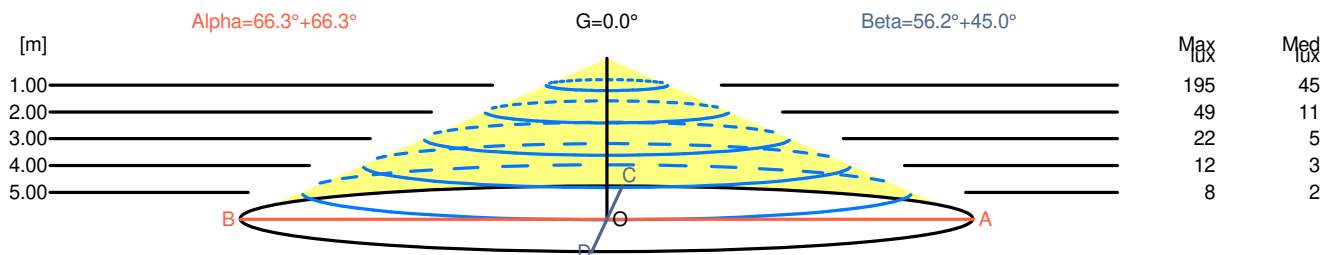

H[m]	D[m]	Max lux	Med lux	Alpha=66.3°+66.3°	G=0.0
1.00	4.55	195	45		
2.00	9.10	49	11		
3.00	13.65	22	5		
4.00	18.20	12	3		
5.00	22.75	8	2		

H[m]	D[m]	Max lux	Med lux	Beta=45.0°+56.2°	G=0.0
1.00	2.49	195	45		
2.00	4.99	49	11		
3.00	7.48	22	5		
4.00	9.98	12	3		
5.00	12.47	8	2		

**Luminaire**

Code 10-7582-05-05

Name ORGANIC

**Measurment.**

Code 10-7582-05-05

Name ORGANIC

Luminaire Flux	771 lm	Luminaire Power	10.9 W	Efficacy	70.775 lm/W	Efficiency	73.12%
Source Flux	1055 lm	Maximum value	189.57 cd/klm	Position	C=270.00 G=20.00	CG	Asymmetrical

Isolux (Floor)

Luminaire position X=0.00m Y=0.00m Z=2.50m

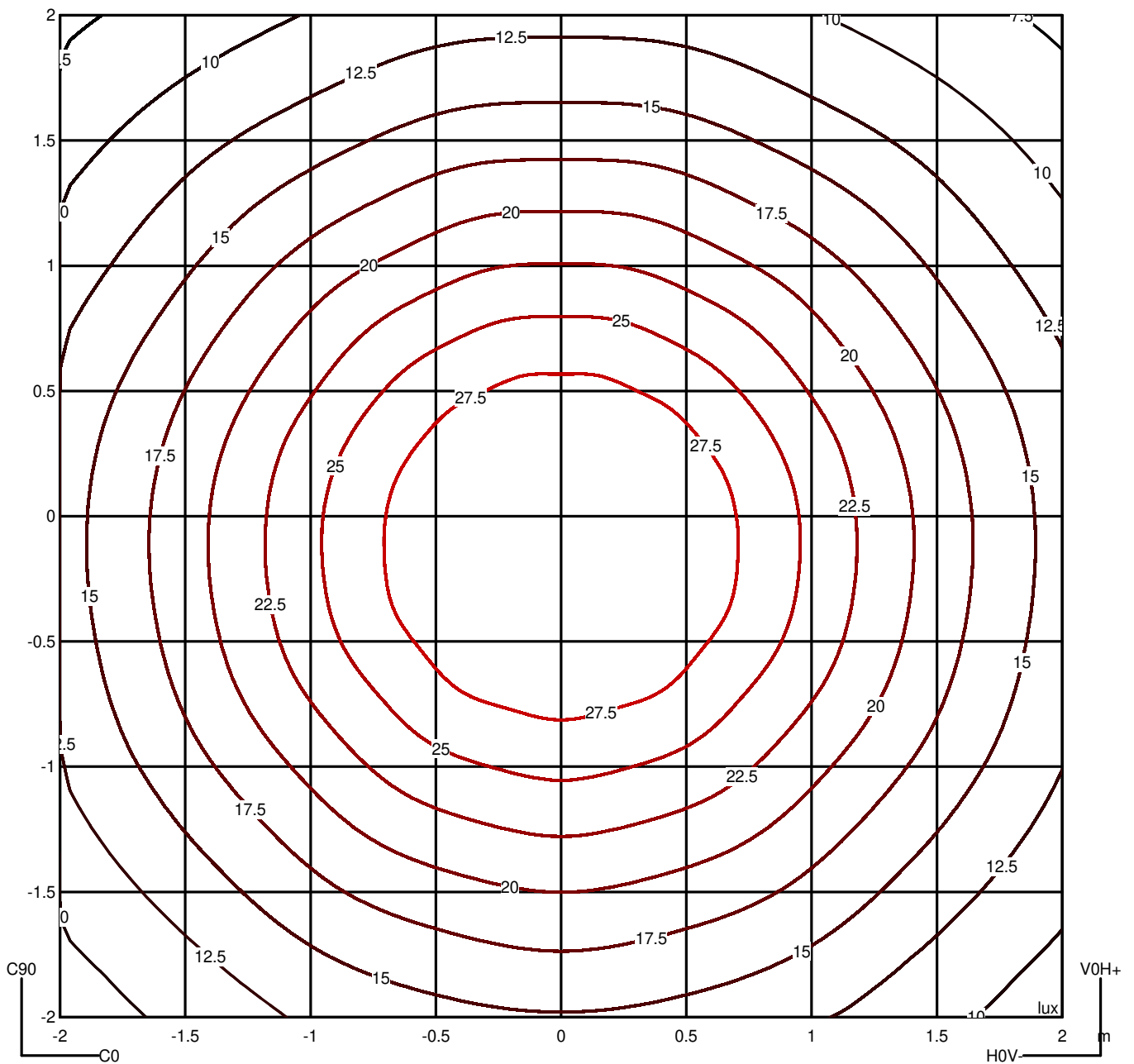

# LedsC4

**Luminaire**

Code 10-7582-05-05  
Name ORGANIC

**Measurem.**

Code 10-7582-05-05  
Name ORGANIC

Luminaire Flux	771 lm	Luminaire Power	10.9 W	Efficacy	70.775 lm/W	Efficiency	73.12%
Source Flux	1055 lm	Maximum value	189.57 cd/klm	Position	C=270.00 G=20.00	CG	Asymmetrical

Luminance

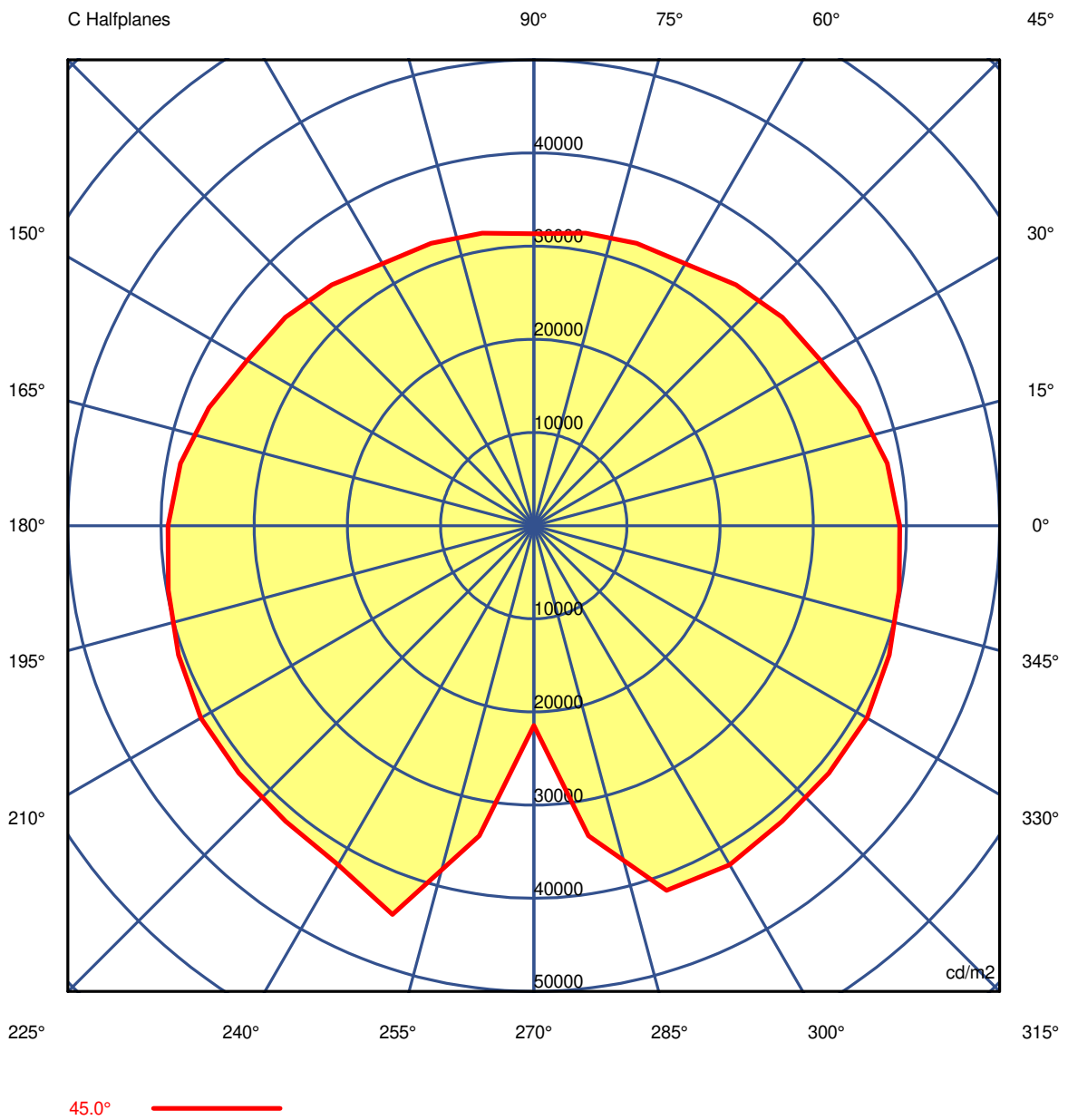

**Luminaire**

Code 10-7582-05-05  
Name ORGANIC

**Measurement**

Code 10-7582-05-05  
Name ORGANIC

Luminaire Flux	771 lm	Luminaire Power	10.9 W	Efficacy	70.775 lm/W	Efficiency	73.12%
Source Flux	1055 lm	Maximum value	189.57 cd/klm	Position	C=270.00 G=20.00	CG	Asymmetrical

**Luminance cd/m2 Table 1/3**

	C 0.00	C 10.00	C 20.00	C 30.00	C 40.00	C 50.00	C 60.00	C 70.00	C 80.00	C 90.00	C 100.00	C 110.00	C 120.00
G 0.0	68880.51	68880.51	68880.51	68880.51	68880.51	68880.51	68880.51	68880.51	68880.51	68880.51	68880.51	68880.51	68880.51
G 5.0	62096.29	61982.77	61835.48	61678.23	61566.95	61460.70	61350.54	61278.33	61264.07	61267.64	61264.07	61278.31	61350.54
G 10.0	56823.69	56643.66	56296.00	55907.45	55754.14	55562.79	55314.51	55256.43	55137.89	54997.80	55137.90	55256.39	55314.51
G 15.0	52589.94	52257.08	51836.37	51405.45	51114.54	50765.66	50441.62	50416.65	50279.97	50082.92	50279.96	50416.66	50441.62
G 20.0	49245.16	48809.49	48291.02	47759.78	47351.49	46875.68	46424.95	46281.75	46051.40	45814.27	46051.39	46281.77	46424.95
G 25.0	46494.63	46023.07	45326.66	44595.59	44199.82	43623.54	42974.07	42876.42	42674.09	42382.91	42674.09	42876.42	42974.07
G 30.0	44343.84	43725.14	42907.84	42055.25	41491.21	40783.09	40064.19	39890.01	39522.43	39102.43	39522.40	39890.06	40064.19
G 35.0	42544.39	41826.29	40790.24	39691.77	39054.85	38253.07	37381.72	37158.67	36785.93	36358.54	36785.89	37158.77	37381.72
G 40.0	40789.03	40052.04	38931.67	37695.02	36922.23	35924.30	34878.52	34673.43	34344.27	33909.60	34344.24	34673.50	34878.52
G 45.0	39250.53	38498.58	37099.80	35529.99	34807.06	33756.15	32476.37	32255.88	31882.91	31352.60	31882.88	32255.92	32476.37
G 50.0	37242.04	36317.07	34263.71	32107.63	31801.97	30667.91	28958.40	29523.79	29346.49	28333.10	29346.46	29523.84	28958.40
G 55.0	34189.61	32874.29	30068.65	27166.93	26823.08	25552.01	23642.11	24676.34	24342.11	22775.86	24342.12	24676.31	23642.11
G 60.0	29121.97	27664.95	24015.07	20379.87	20798.47	19595.78	17023.49	18744.92	18836.95	17028.71	18837.07	18744.64	17023.49
G 65.0	23397.77	21439.93	17766.48	14296.31	14434.82	13456.00	11445.03	12855.73	12435.37	10466.16	12435.42	12855.63	11445.03
G 70.0	17808.19	15686.66	11561.03	7714.80	8246.35	7864.90	6056.45	7228.37	7078.63	5593.43	7078.60	7228.44	6056.45
G 75.0	11285.14	8966.35	5806.50	3242.99	3497.27	3119.70	1938.16	2930.13	2992.63	2028.81	2992.63	2930.13	1938.16
G 80.0	6585.42	4334.53	2150.52	627.93	515.42	372.23	138.18	315.35	311.40	115.98	311.39	315.37	138.18
G 85.0	2289.79	1008.55	288.84	145.11	137.09	133.87	133.17	127.33	114.31	104.84	114.41	127.11	133.17
G 90.0	308.43	197.03	157.11	148.15	138.18	140.12	147.86	124.26	112.12	111.61	108.78	123.77	147.86

**Luminaire**

 Code 10-7582-05-05  
 Name ORGANIC

**Measurement**

 Code 10-7582-05-05  
 Name ORGANIC

Luminaire Flux	771 lm	Luminaire Power	10.9 W	Efficacy	70.775 lm/W	Efficiency	73.12%
Source Flux	1055 lm	Maximum value	189.57 cd/klm	Position	C=270.00 G=20.00	CG	Asymmetrical

**Luminance cd/m2 Table 2/3**

	C 130.00	C 140.00	C 150.00	C 160.00	C 170.00	C 180.00	C 190.00	C 200.00	C 210.00	C 220.00	C 230.00	C 240.00	C 250.00
G 0.0	68880.51	68880.51	68880.51	68880.51	68880.51	68880.51	68880.51	68880.51	68880.51	68880.51	68880.51	68880.51	68880.51
G 5.0	61460.77	61566.78	61678.23	61836.45	61980.33	62096.29	62239.54	62440.54	62609.46	62636.74	62769.81	62964.65	62918.55
G 10.0	55562.96	55753.71	55907.45	56298.37	56637.69	56823.69	57052.54	57376.62	57662.55	57751.26	57944.92	58189.82	58145.31
G 15.0	50765.58	51114.74	51405.45	51835.25	52259.92	52589.94	52897.82	53314.70	53700.93	53805.93	54042.60	54349.54	54273.25
G 20.0	46875.54	47351.83	47759.78	48289.12	48814.29	49245.16	49632.59	50105.86	50520.41	50627.25	50895.44	51236.77	51124.69
G 25.0	43623.54	44199.81	44595.59	45326.72	46022.92	46494.63	46947.28	47506.72	47978.75	48083.36	48344.32	48689.79	48562.27
G 30.0	40782.81	41491.91	42055.25	42903.98	43734.91	44343.84	44840.73	45412.38	45891.32	45972.19	46239.71	46611.64	46460.83
G 35.0	38252.51	39056.25	39691.77	40782.54	41845.76	42544.39	43029.34	43644.34	44192.60	44213.74	44477.74	44912.17	44716.71
G 40.0	35923.96	36923.10	37695.02	38926.86	40064.19	40789.03	41358.02	42063.25	42654.86	42668.66	42912.24	43396.84	43300.23
G 45.0	33755.90	34807.69	35529.99	37096.31	38507.40	39250.53	39828.58	40584.25	41279.29	41325.11	41432.44	42031.40	44400.84
G 50.0	30667.65	31802.64	32107.63	34260.01	36326.43	37242.04	37931.67	38973.16	39911.30	39818.71	39976.28	40665.71	42230.29
G 55.0	25552.17	26822.68	27166.93	30070.87	32868.67	34189.61	35366.69	36936.63	38209.96	38116.65	38015.49	39188.38	40431.71
G 60.0	19597.26	20794.73	20379.87	24035.71	27612.80	29121.97	30910.51	33749.80	36201.57	36192.99	36087.97	37536.53	38745.92
G 65.0	13456.51	14433.54	14296.31	17773.54	21422.08	23397.77	25490.97	29042.37	32580.74	33321.31	33762.71	35543.26	36678.90
G 70.0	7864.53	8247.29	7714.80	11555.84	15699.78	17808.19	19814.98	23964.08	28514.68	29607.08	30796.73	33542.15	34533.69
G 75.0	3119.69	3497.31	3242.99	5806.29	8966.88	11285.14	13776.90	18138.31	23001.96	25262.41	27560.97	30893.63	32298.50
G 80.0	372.11	515.42	627.93	2148.87	4338.70	6585.42	9137.83	13571.31	18514.51	20891.26	23730.12	27805.11	29564.45
G 85.0	133.11	129.46	145.11	305.46	966.54	2289.79	4527.23	9147.40	14386.94	16762.17	19866.85	24629.22	27137.07
G 90.0	142.75	131.54	148.15	157.11	210.54	308.43	1773.61	5439.48	9877.06	12623.15	16331.33	21407.23	24367.88

**Luminaire**

Code 10-7582-05-05  
Name ORGANIC

**Measur.**

Code 10-7582-05-05  
Name ORGANIC

Luminaire Flux	771 lm	Luminaire Power	10.9 W	Efficacy	70.775 lm/W	Efficiency	73.12%
Source Flux	1055 lm	Maximum value	189.57 cd/klm	Position	C=270.00 G=20.00	CG	Asymmetrical

**Luminance cd/m2 Table 3/3**

	C 260.00	C 270.00	C 280.00	C 290.00	C 300.00	C 310.00	C 320.00	C 330.00	C 340.00	C 350.00
G 0.0	68880.51	68880.51	68880.51	68880.51	68880.51	68880.51	68880.51	68880.51	68880.51	68880.51
G 5.0	62900.65	62942.92	62900.64	62918.55	62964.65	62769.75	62636.91	62609.46	62439.57	62241.99
G 10.0	58189.32	58325.88	58189.30	58145.34	58189.82	57944.75	57751.69	57662.55	57374.26	57058.51
G 15.0	54331.01	54520.08	54331.02	54273.23	54349.54	54042.68	53805.73	53700.93	53315.82	52894.98
G 20.0	51197.61	51436.46	51197.62	51124.66	51236.77	50895.58	50626.90	50520.41	50107.76	49627.79
G 25.0	48618.47	48852.70	48618.47	48562.27	48689.79	48344.32	48083.37	47978.75	47506.65	46947.44
G 30.0	46508.01	46756.79	46508.03	46460.77	46611.64	46239.99	45971.48	45891.32	45416.24	44830.97
G 35.0	44749.91	45033.87	44749.96	44716.61	44912.17	44478.30	44212.34	44192.60	43652.04	43009.87
G 40.0	42939.95	42759.12	42939.98	43300.17	43396.84	42912.59	42667.79	42654.86	42068.06	41345.87
G 45.0	33810.99	21443.75	33811.01	41647.97	42031.40	41432.44	41324.47	41279.29	40587.74	39819.76
G 50.0	34528.35	25722.36	34528.38	40237.28	40665.71	39976.28	39818.04	39911.30	38976.86	37922.31
G 55.0	34085.46	26934.53	34085.45	38780.78	39188.38	38015.33	38117.06	38209.96	36934.41	35372.31
G 60.0	32222.04	24987.46	32221.91	37044.89	37536.53	36086.49	36196.74	36201.57	33729.17	30962.66
G 65.0	30206.01	23146.11	30205.97	34985.49	35543.26	33762.21	33322.59	32580.74	29035.31	25508.82
G 70.0	27970.06	21152.69	27970.09	34533.62	33542.15	30797.10	29606.13	28514.68	23969.27	19801.85
G 75.0	26049.66	19370.96	26049.66	32298.50	30893.63	27560.99	25262.37	23001.96	18138.52	13776.37
G 80.0	23959.04	17867.47	23959.05	29564.43	27805.11	23730.24	20890.96	18514.51	13572.96	9133.65
G 85.0	22511.52	17064.95	22511.42	27137.29	24629.22	19865.65	16765.19	14386.94	9130.78	4569.23
G 90.0	20828.29	16235.83	20828.07	24368.37	21407.23	16328.70	12629.79	9877.06	5402.89	1866.08

## Luminaire

Code 10-7582-05-05  
Name ORGANIC

## Measurement

Code 10-7582-05-05  
Name ORGANIC

Luminaire Flux	771 lm	Luminaire Power	10.9 W	Efficacy	70.775 lm/W	Efficiency	73.12%
Source Flux	1055 lm	Maximum value	189.57 cd/klm	Position	C=270.00 G=20.00	CG	Asymmetrical

## US ROAD STANDARDS

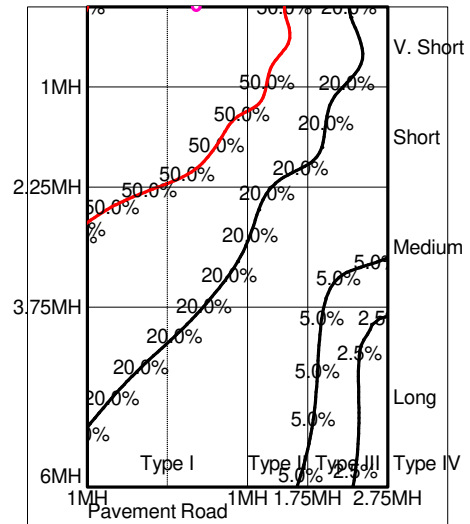
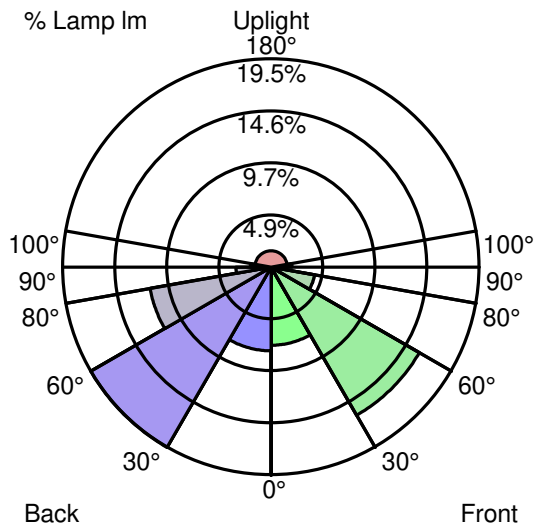

## Luminaire Classification System (LCS)

LCS Zone		Lumens	%Lamp	%Lum
FL	0° -- 30°	77.2 lm	7.3 %	10.0 %
FM	30° -- 60°	168.9 lm	16.0 %	21.9 %
FH	60° -- 80°	43.6 lm	4.1 %	5.7 %
FVH	80° -- 90°	1.0 lm	0.1 %	0.1 %
BL	0° -- 30°	82.7 lm	7.8 %	10.7 %
BM	30° -- 60°	205.5 lm	19.5 %	26.6 %
BH	60° -- 80°	121.3 lm	11.5 %	15.7 %
BVH	80° -- 90°	34.7 lm	3.3 %	4.5 %
UL	90° -- 100°	20.4 lm	1.9 %	2.6 %
UH	100° -- 180°	16.0 lm	1.5 %	2.1 %
TOTALS		771.4 lm	73.1 %	100.0 %
BUG B1 U2 G1 Type II Very Short Asymmetrical				

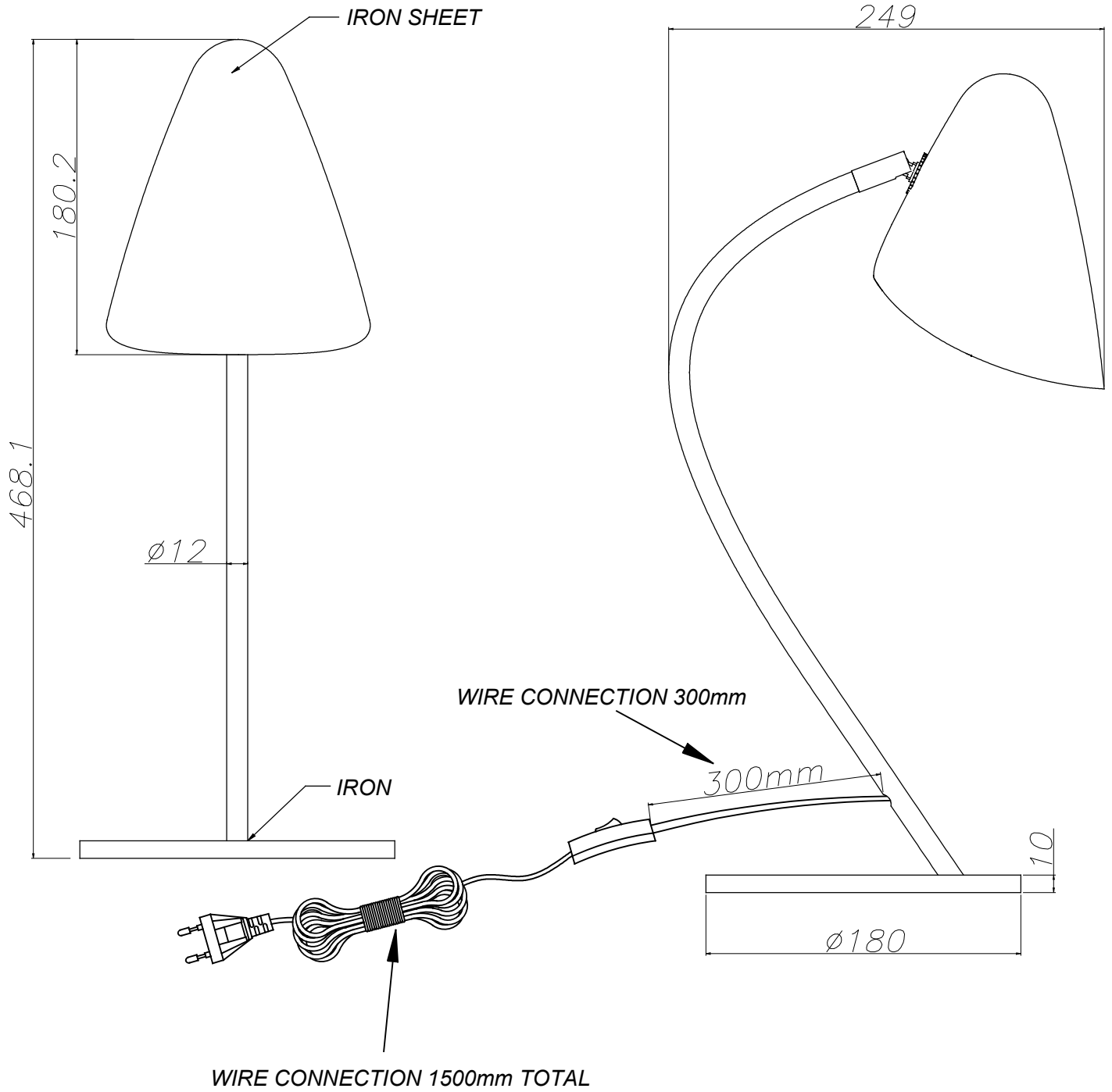



# ORGANIC

TABLE

