



Levels 1 Body Ø420mm

Nahtrang Studio

Sobremesa Levels 1 Body Ø420mm LED 14.7W SW 2700-3000-4000K 3 STEPS DIMMING Negro 972lm

Características técnicas

Potencia total luminaria: 14.7W

Lúmenes reales: 1069 (3000K)

Lm / W reales: 73

Temperatura de color correlacionada (CCT): SW
2700-3000-4000K

Ángulo Ópticas / Reflector: HORIZONTAL 102°

Material de la estructura: Acero

Acabado estructura: Negro

Material del difusor: Cristal

Acabado difusor: Ámbar

Marca Driver: MEAN WELL

Voltaje / Frecuencia: 100-240V ~ 50/60Hz

Protocolo de regulación: 3 STEPS DIMMING

Power Factor: NULL

Vida útil: 50,000h L80B20

Garantía: 5 años

Luminaria fácilmente reciclable



Características luminotécnicas

CRI: 92

MacAdam steps: 3

Riesgo fotobiológico: RG1

Portalámparas	Cantidad	Potencia fuente de luz (W)
LED	1	11.8W

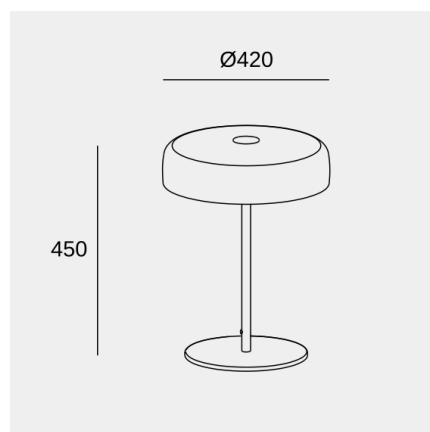

La imagen puede no coincidir con la referencia, LedsC4 se reserva el derecho de modificación de alguno de los componentes que componen el producto. Los datos relativos al flujo, la potencia y la temperatura de color pueden estar sujetos a cambios del fabricante.



Levels 1 Body Ø420mm

Nahtrang Studio

Sobremesa Levels 1 Body Ø420mm LED 14.7W SW 2700-3000-4000K 3 STEPS DIMMING Negro 972lm

Aplicación de la luminaria



La imagen puede no coincidir con la referencia, LedsC4 se reserva el derecho de modificación de alguno de los componentes que componen el producto. Los datos relativos al flujo, la potencia y la temperatura de color pueden estar sujetos a cambios del fabricante.

Luminaria

Código 10-A004-05-15V2_2700
 Nombre LEVELS
 Familia OXL

Ensayo

Código 10-A004-05-15V2_2700
 Nombre LEVELS

Datos Fuente de luz

Código LED	Temp. de Color Correlacionada (TCP) 2700K	Cant. 1
Nombre LED	Índice repr. Cromática (CRI) 90	
Familia		

Datos del Ensayo

Sist. de Coorden. CG	Tipo de Simetría Rotosimétrico
Fecha 16-09-2022	Máximo Ángulo Gamma 90°
Distancia de Ensayo 0.00m	Flujo de Ensayo 936.1 lm
Máximo 365.05 cd/klm	Posición C=0.0° G=13.0°

Parám. Eléctricos

Canal 1	Canal 2
Tensión 0.00 V	Tensión 0.00 V
Corriente 0.00 A	Corriente 0.00 A
Potencia 14.70 W	Potencia 0.00 W
Frecuencia 0 Hz	Frecuencia 0 Hz
Factor de Potencia 0.00	Factor de Potencia 0.00

Parámetros Ambientales

Temperatura 0.0 °C	Velocidad del Aire 0.0 m/s
Humedad 0.0 %	

Dim. de la Luminaria

Luminaria Redonda	Diam. 215 mm	Altura 215 mm	
Área Luminosa Redonda	Diam. 115 mm	Altura 0 mm	
Área Luminosa Horizontal	0.010387 m2	Área Emisión sobre Pl. 180°	0.000000 m2
Área Emisión sobre Pl. 0°	0.000000 m2	Área Emisión sobre Pl. 270°	0.000000 m2
Área Emisión sobre Pl. 90°	0.000000 m2	Área de deslumbramiento a 76°	0.002513 m2

Análisis Fotométrico

Flujo Luminaria 936.0 lm	Flujo Fuente 936.0 lm
Eficacia 63.673 lm/W	Eficiencia 100.0 %
Códigos de Flujo C.I.E. 45 74 92 100 100	D DIN 5040 A30
F UTE 1.00 E	B NBN BZ 5

Diam=215mm

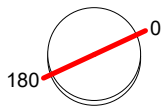

Semiplanos C
 180.0 ————— 0.0

ULOR 0.00 %
 DLOR 100.00 %
 RN 0.00 %

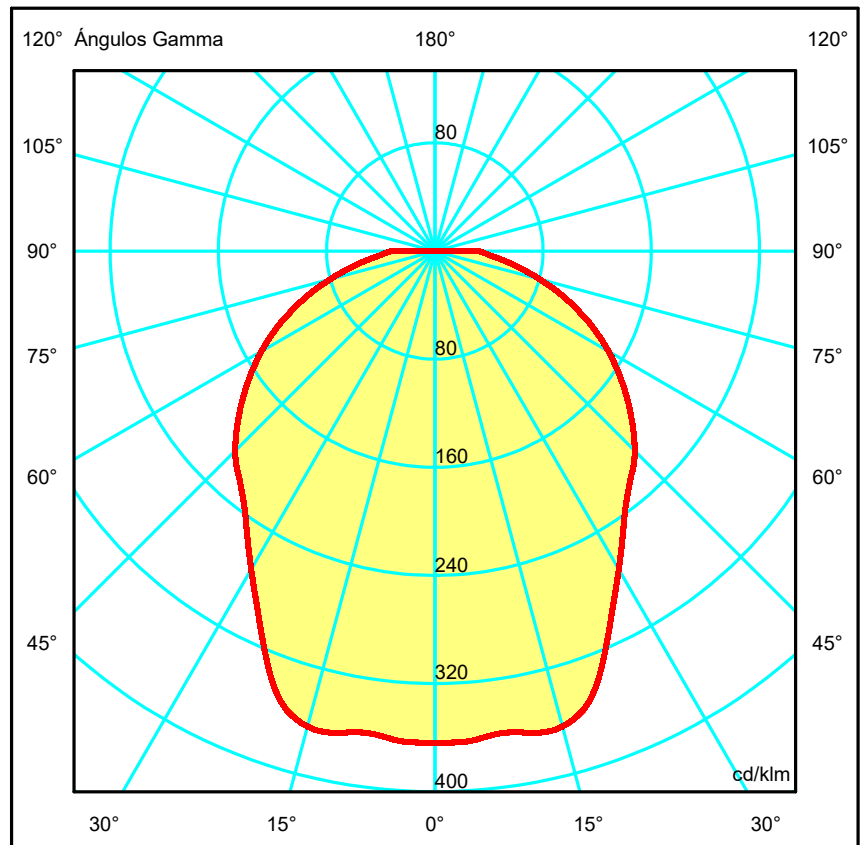

Luminaria

Código 10-A004-05-15V2_2700

Nombre LEVELS

Ensayo

Código 10-A004-05-15V2_2700

Nombre LEVELS

Flujo Luminaria	936 lm	Potencia Luminaria	14.7 W	Eficacia	63.673 lm/W	Eficiencia	100.00%
Flujo Fuente	936 lm	Valor Máximo	365.05 cd/klm	Posición	C=0.00 G=13.00	CG	Rotosimétrico

Tabla de Intensidad Luminosa cd/klm
Tabla 1/1

	C 0.00	C 0.00	
G 0.0	363.80	G 46.0	205.09
G 1.0	363.74	G 47.0	201.24
G 2.0	363.68	G 48.0	197.29
G 3.0	363.66	G 49.0	193.27
G 4.0	363.42	G 50.0	189.28
G 5.0	362.58	G 51.0	185.28
G 6.0	361.29	G 52.0	181.17
G 7.0	360.24	G 53.0	177.06
G 8.0	359.77	G 54.0	172.99
G 9.0	360.36	G 55.0	168.91
G 10.0	361.47	G 56.0	164.76
G 11.0	362.94	G 57.0	160.55
G 12.0	364.29	G 58.0	156.41
G 13.0	365.05	G 59.0	152.34
G 14.0	365.01	G 60.0	148.17
G 15.0	364.04	G 61.0	143.85
G 16.0	362.36	G 62.0	139.49
G 17.0	359.90	G 63.0	135.09
G 18.0	356.49	G 64.0	130.70
G 19.0	351.50	G 65.0	126.17
G 20.0	345.21	G 66.0	121.53
G 21.0	337.97	G 67.0	116.89
G 22.0	330.19	G 68.0	112.34
G 23.0	322.06	G 69.0	107.77
G 24.0	313.75	G 70.0	103.08
G 25.0	305.77	G 71.0	98.39
G 26.0	298.17	G 72.0	93.79
G 27.0	291.08	G 73.0	89.29
G 28.0	284.29	G 74.0	84.76
G 29.0	277.85	G 75.0	80.24
G 30.0	271.68	G 76.0	75.78
G 31.0	265.65	G 77.0	71.43
G 32.0	260.00	G 78.0	67.18
G 33.0	254.47	G 79.0	63.04
G 34.0	248.96	G 80.0	59.13
G 35.0	243.55	G 81.0	55.41
G 36.0	238.75	G 82.0	51.91
G 37.0	234.57	G 83.0	48.60
G 38.0	230.79	G 84.0	45.52
G 39.0	227.33	G 85.0	42.74
G 40.0	224.02	G 86.0	40.21
G 41.0	221.05	G 87.0	37.85
G 42.0	218.22	G 88.0	35.73
G 43.0	215.45	G 89.0	33.87
G 44.0	212.35	G 90.0	32.19
G 45.0	208.79		

LedsC4

Luminaria

Código 10-A004-05-15V2_2700

Nombre LEVELS

Ensayo

Código 10-A004-05-15V2_2700

Nombre LEVELS

Flujo Luminaria	936 lm	Potencia Luminaria	14.7 W	Eficacia	63.673 lm/W	Eficiencia	100.00%
Flujo Fuente	936 lm	Valor Máximo	365.05 cd/klm	Posición	C=0.00 G=13.00	CG	Rotosimétrico

Diam=215mm

Semiplanos C

180.0  0.0

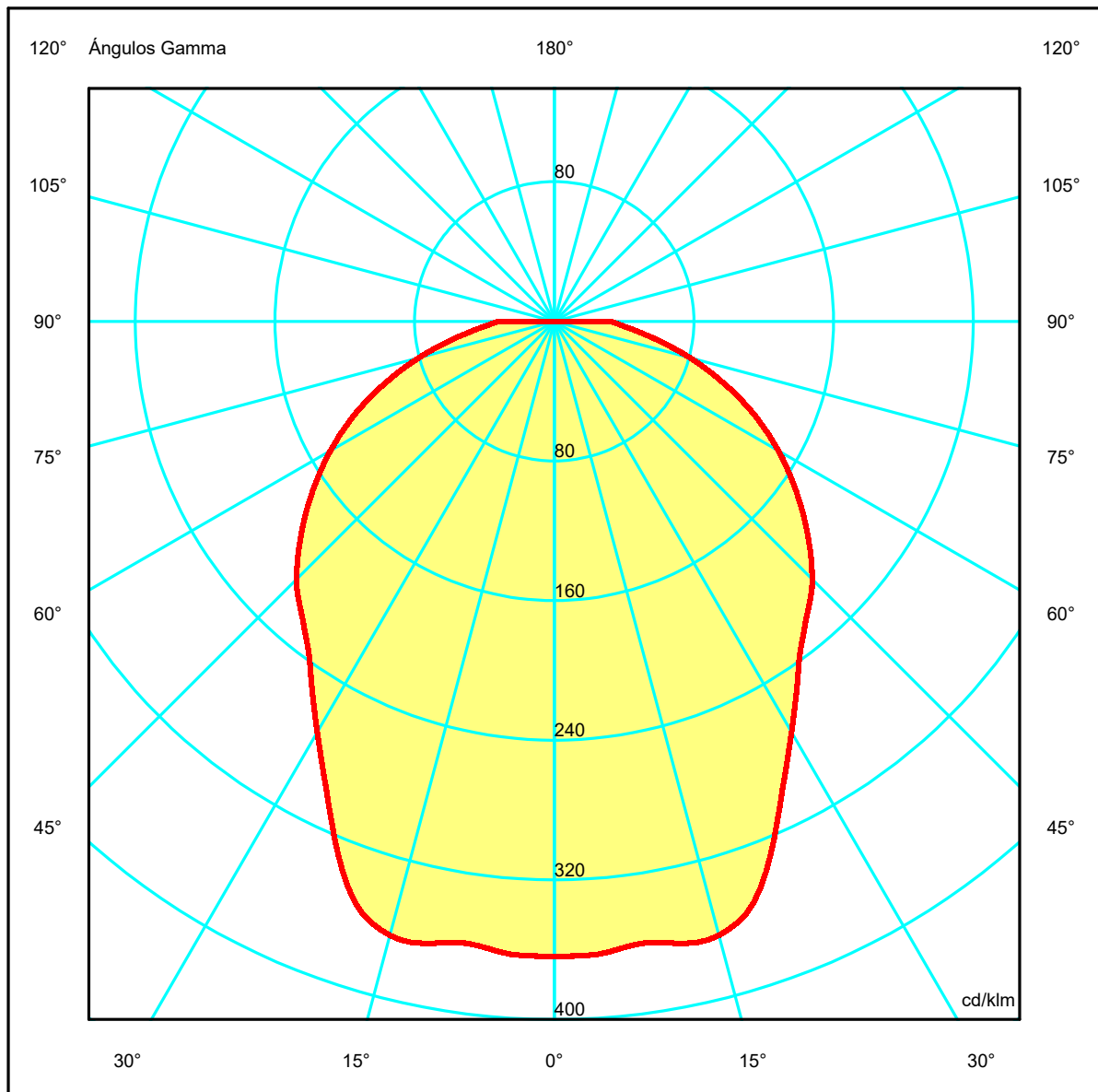
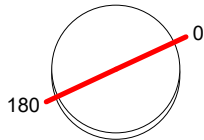

Luminaria

Código 10-A004-05-15V2_2700

Nombre LEVELS

Ensayo

Código 10-A004-05-15V2_2700

Nombre LEVELS

Flujo Luminaria	936 lm	Potencia Luminaria	14.7 W	Eficacia	63.673 lm/W	Eficiencia	100.00%
Flujo Fuente	936 lm	Valor Máximo	365.05 cd/klm	Posición	C=0.00 G=13.00	CG	Rotosimétrico

Diam=215mm

Semiplanos C

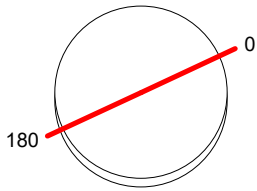

180.0 ————— 0.0

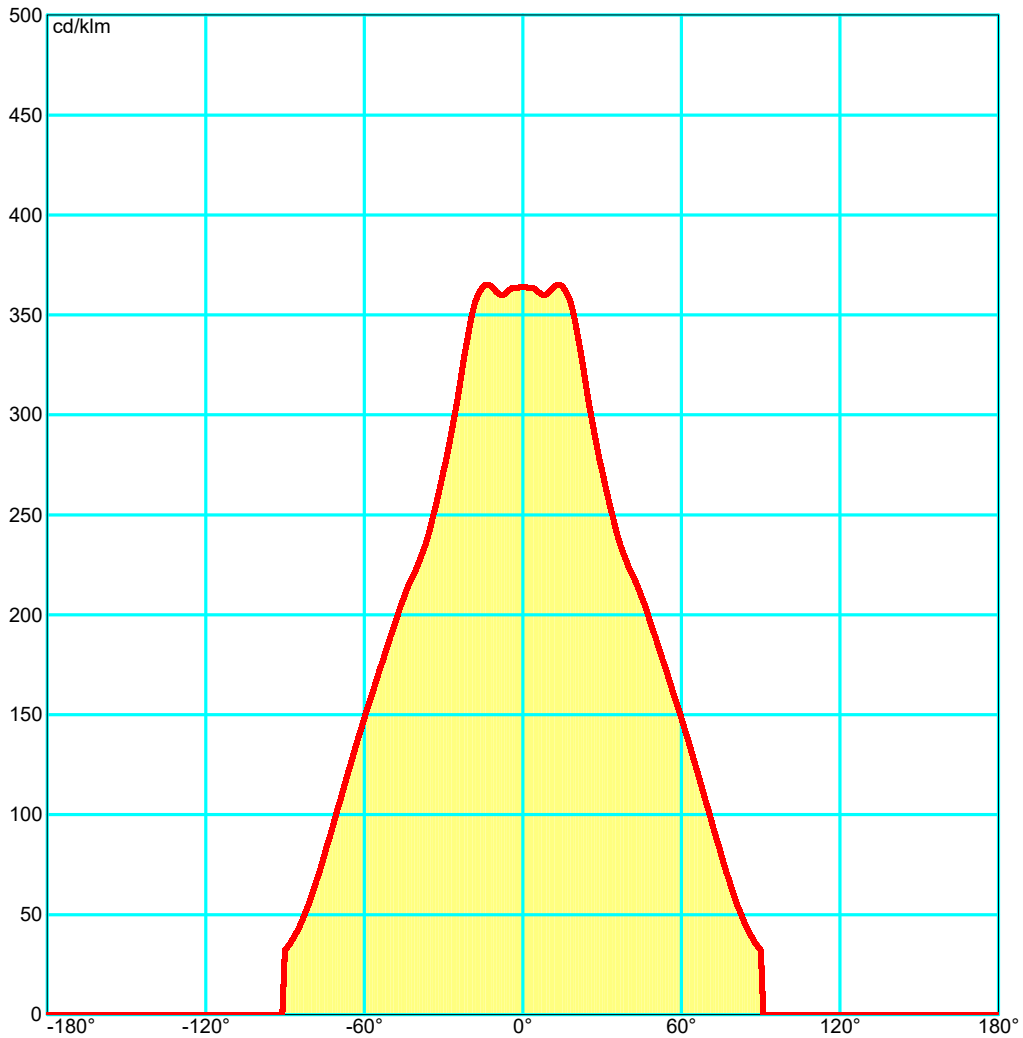

Luminaria

Código 10-A004-05-15V2_2700

Nombre LEVELS

Ensayo

Código 10-A004-05-15V2_2700

Nombre LEVELS

Flujo Luminaria	936 lm	Potencia Luminaria	14.7 W	Eficacia	63.673 lm/W	Eficiencia	100.00%
Flujo Fuente	936 lm	Valor Máximo	365.05 cd/klm	Posición	C=0.00 G=13.00	CG	Rotosimétrico

UGR
S = 0.250

Reflectancias										
Techo/Cavidad	0.7	0.7	0.5	0.5	0.3	0.7	0.7	0.5	0.5	0.3
Paredes	0.5	0.3	0.5	0.3	0.3	0.5	0.3	0.5	0.3	0.3
PDT	0.2	0.2	0.2	0.2	0.2	0.2	0.2	0.2	0.2	0.2
Dimensiones del Local										
	Vista Lateral					Vista Longitudinal				
x=2H y=2H	23.9	25.2	24.2	25.5	25.7	23.9	25.2	24.2	25.5	25.7
x=2H y=3H	25.8	27.0	26.1	27.3	27.6	25.8	27.0	26.1	27.3	27.6
x=2H y=4H	26.6	27.8	27.0	28.1	28.4	26.6	27.8	27.0	28.1	28.4
x=2H y=6H	27.4	28.5	27.8	28.8	29.2	27.4	28.5	27.8	28.8	29.2
x=2H y=8H	27.8	28.9	28.2	29.2	29.5	27.8	28.9	28.2	29.2	29.5
x=2H y=12H	28.3	29.3	28.6	29.6	30.0	28.3	29.3	28.6	29.6	30.0
x=4H y=2H	24.6	25.8	25.0	26.1	26.4	24.6	25.8	25.0	26.1	26.4
x=4H y=3H	26.7	27.8	27.1	28.1	28.4	26.7	27.8	27.1	28.1	28.4
x=4H y=4H	27.8	28.7	28.2	29.0	29.4	27.8	28.7	28.2	29.0	29.4
x=4H y=6H	28.7	29.6	29.2	29.9	30.3	28.7	29.6	29.2	29.9	30.3
x=4H y=8H	29.2	30.0	29.7	30.4	30.8	29.2	30.0	29.7	30.4	30.8
x=4H y=12H	29.8	30.4	30.2	30.9	31.3	29.8	30.4	30.2	30.9	31.3
x=8H y=4H	28.2	28.9	28.6	29.3	29.8	28.2	28.9	28.6	29.3	29.8
x=8H y=6H	29.4	30.0	29.9	30.4	30.9	29.4	30.0	29.9	30.4	30.9
x=8H y=8H	30.0	30.6	30.5	31.0	31.5	30.0	30.6	30.5	31.0	31.5
x=8H y=12H	30.7	31.2	31.2	31.7	32.2	30.7	31.2	31.2	31.7	32.2
x=12H y=4H	28.3	29.0	28.7	29.4	29.8	28.3	29.0	28.7	29.4	29.8
x=12H y=6H	29.5	30.1	30.0	30.5	31.0	29.5	30.1	30.0	30.5	31.0
x=12H y=8H	30.3	30.7	30.7	31.2	31.7	30.3	30.7	30.7	31.2	31.7

Luminaria

Código 10-A004-05-15V2_2700
 Nombre LEVELS
 Ensayo
 Código 10-A004-05-15V2_2700
 Nombre LEVELS

Flujo Luminaria	936 lm	Potencia Luminaria	14.7 W	Eficacia	63.673 lm/W	Eficiencia	100.00%
Flujo Fuente	936 lm	Valor Máximo	365.05 cd/klm	Posición	C=0.00 G=13.00	CG	Rotosimétrico

Flujo Total=936.00 Flujo Luminaria=936.00

RI	0.60	0.80	1.00	1.25	1.50	2.00	2.50	3.00	4.00	5.00	10.00	20.00
DRR	0.30	0.38	0.44	0.51	0.57	0.65	0.71	0.75	0.80	0.83	0.91	0.95
RC	5	5	5	5	6	6	6	6	6	6	6	6

Flujo Zonal por 1000 Lúmenes

Y°	10	20	30	40	50	60	70	80	90	100	110	120	130	140	150	160	170	180
ZF(Y)	34	136	277	431	592	743	867	952	1000	1000	1000	1000	1000	1000	1000	1000	1000	1000

Códigos de Flujo C.I.E.

45 74 92 100 100

C.I.E. 5/5/5/6/6/6/6/6/6/6
 D DIN 5040 A30
 F UTE 1.00 E
 B NBN BZ 5
 RN 0.00000 %
 BLF 1.0

LOR 100.00000 %
 ULOR 0.00000 %
 DLOR 100.00000 %
 UFF 0.00000 %
 DFF 100.00000 %
 FFR 0.00000 %

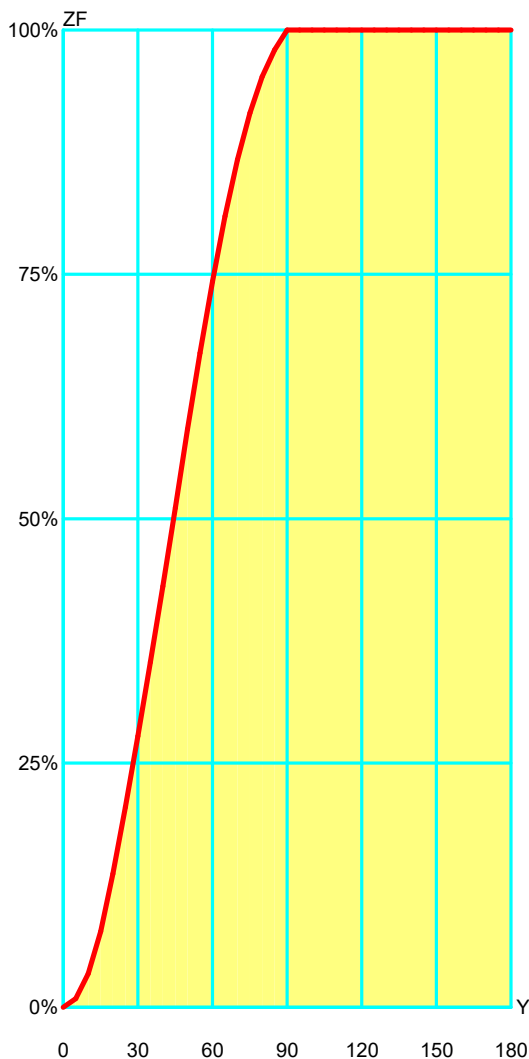

Flujo Zonal				
Gamma °	Flujo	Suma lm	Flujo [%]	Suma [%]
0°	0.00	0.00	0.00%	0.00 %
5°	8.69	8.69	0.87 %	0.87 %
10°	25.80	34.49	2.58 %	3.45 %
15°	43.20	77.69	4.32 %	7.77 %
20°	58.77	136.46	5.88 %	13.65 %
25°	68.22	204.68	6.82 %	20.47 %
30°	72.78	277.46	7.28 %	27.75 %
35°	75.70	353.16	7.57 %	35.32 %
40°	77.70	430.87	7.77 %	43.09 %
45°	80.20	511.07	8.02 %	51.11 %
50°	80.45	591.52	8.04 %	59.15 %
55°	77.85	669.36	7.78 %	66.94 %
60°	73.24	742.61	7.32 %	74.26 %
65°	66.70	809.30	6.67 %	80.93 %
70°	58.02	867.32	5.80 %	86.73 %
75°	47.85	915.17	4.78 %	91.52 %
80°	37.13	952.30	3.71 %	95.23 %
85°	27.42	979.73	2.74 %	97.97 %
90°	20.27	1000.00	2.03 %	100.00 %
95°	0.00	1000.00	0.00 %	100.00 %
100°	0.00	1000.00	0.00 %	100.00 %
105°	0.00	1000.00	0.00 %	100.00 %
110°	0.00	1000.00	0.00 %	100.00 %
115°	0.00	1000.00	0.00 %	100.00 %
120°	0.00	1000.00	0.00 %	100.00 %
125°	0.00	1000.00	0.00 %	100.00 %
130°	0.00	1000.00	0.00 %	100.00 %
135°	0.00	1000.00	0.00 %	100.00 %
140°	0.00	1000.00	0.00 %	100.00 %
145°	0.00	1000.00	0.00 %	100.00 %
150°	0.00	1000.00	0.00 %	100.00 %
155°	0.00	1000.00	0.00 %	100.00 %
160°	0.00	1000.00	0.00 %	100.00 %
165°	0.00	1000.00	0.00 %	100.00 %
170°	0.00	1000.00	0.00 %	100.00 %
175°	0.00	1000.00	0.00 %	100.00 %
180°	0.00	1000.00	0.00 %	100.00 %

Luminaria

Código 10-A004-05-15V2_2700

Nombre LEVELS

Ensayo

Código 10-A004-05-15V2_2700

Nombre LEVELS

Flujo Luminaria	936 lm	Potencia Luminaria	14.7 W	Eficacia	63.673 lm/W	Eficiencia	100.00%
Flujo Fuente	936 lm	Valor Máximo	365.05 cd/klm	Posición	C=0.00 G=13.00	CG	Rotosimétrico

Utilización CIE

Montaje	Directo	Gestión Imágenes										Normalizados			Raz. de Susp. 1/3			CIE Estándar					
Techo																							
K	8873	8773	8871	8771	7773	7771	7753	7553	7751	7551	7731	7331	7711	7111	5551	5531	5331	5511	5111	3331	3311	1111	0000
0.60	218	196	173	156	187	149	112	95	88	75	47	35	17	12	70	38	33	14	11	32	12	10	0
0.80	254	233	186	171	222	164	141	123	101	89	57	45	23	17	83	47	43	20	16	41	17	15	0
1.00	278	258	189	177	246	170	164	146	109	98	64	53	29	22	92	54	50	25	21	47	22	19	0
1.25	299	281	188	178	268	171	188	170	115	105	71	60	35	28	98	61	57	31	27	54	28	25	0
1.50	313	298	185	177	283	170	207	190	117	109	75	66	41	34	103	67	63	37	33	60	33	30	0
2.00	331	319	175	169	304	164	235	220	119	112	82	74	50	43	106	74	70	46	42	67	42	39	0
2.50	343	332	167	162	317	158	256	242	119	114	86	79	58	51	108	79	76	53	49	73	49	46	0
3.00	351	342	160	157	326	152	271	259	119	114	89	83	63	57	109	82	80	59	55	77	55	52	0
4.00	362	355	151	149	339	145	293	282	118	114	93	88	71	66	110	87	85	67	64	82	63	60	0
5.00	369	363	145	143	347	140	308	299	117	114	96	92	77	72	110	91	89	73	70	86	69	66	0
10.00	383	379	130	129	364	127	341	335	114	113	102	100	90	87	109	98	97	87	85	94	84	81	0
20.00	389	387	120	120	372	118	359	356	111	111	105	104	98	97	108	102	101	95	94	99	93	90	0

Pared

K	8873	8773	8871	8771	7773	7771	7753	7553	7751	7551	7731	7331	7711	7111	5551	5531	5331	5511	5111	3331	3311	1111	0000
0.60	472	460	414	405	453	401	357	349	324	318	271	267	233	232	315	267	266	232	231	265	231	231	211
0.80	535	523	457	449	513	443	418	408	370	364	317	312	278	275	359	312	310	276	275	308	275	273	250
1.00	579	567	483	476	555	469	463	452	401	395	350	344	311	307	389	344	342	308	306	339	306	305	278
1.25	619	607	505	499	593	491	506	495	429	423	381	375	343	339	416	374	372	339	337	368	337	335	305
1.50	649	638	520	515	621	507	540	529	450	445	405	399	368	364	437	397	395	364	362	391	361	358	326
2.00	684	674	532	528	654	520	583	572	472	468	433	427	399	395	458	424	422	394	392	417	390	387	350
2.50	706	698	539	535	676	527	613	602	486	482	451	446	421	416	473	442	440	415	413	434	410	406	367
3.00	721	714	542	539	691	531	634	624	495	492	464	459	437	432	482	454	452	430	427	446	424	419	378
4.00	749	742	553	551	717	543	670	661	514	511	488	484	464	460	500	478	476	457	454	468	450	444	400
5.00	769	764	563	562	738	554	696	689	529	527	507	503	486	482	516	496	494	477	475	486	470	463	417
10.00	821	818	592	592	789	584	764	760	570	568	556	554	543	540	556	544	543	533	531	534	523	515	464
20.00	853	851	611	610	820	603	806	804	595	594	587	586	579	577	582	575	574	568	567	564	558	548	495

P.Trab.

K	8873	8773	8871	8771	7773	7771	7753	7553	7751	7551	7731	7331	7711	7111	5551	5531	5331	5511	5111	3331	3311	1111	0000
0.60	588	575	549	539	567	533	451	443	434	428	366	362	318	316	424	362	360	316	316	359	316	315	297
0.80	692	677	637	627	665	619	547	536	521	514	452	446	399	396	508	445	443	397	396	441	395	394	376
1.00	773	758	705	695	742	685	627	615	593	585	524	517	471	467	577	516	513	467	465	509	465	463	444
1.25	850	836	766	758	816	746	706	692	661	653	595	587	542	537	643	585	582	537	535	577	533	531	512
1.50	908	894	811	804	871	791	767	753	712	705	649	641	598	592	693	638	635	592	589	628	587	583	565
2.00	993	981	875	869	953	856	861	847	789	783	734	726	687	680	768	720	717	679	675	708	672	666	650
2.50	1000	1000	916	911	1000	897	925	911	839	834	790	783	747	741	817	775	772	738	734	762	729	722	706
3.00	1000	1000	943	939	1000	925	972	959	875	870	831	824	792	785	852	814	812	781	777	800	771	763	748
4.00	1000	1000	977	974	1000	960	1000	1000	919	915	882	876	849	843	896	865	862	836	833	849	824	814	800
5.00	1000	1000	997	995	1000	981	1000	1000	947	943	915	910	886	880	923	896	894	871	868	880	858	847	833
10.00	1000	1000	1000	1000	1000	1000	1000	1000	1000	1000	987	984	969	965	982	967	965	951	949	948	935	919	907
20.00	1000	1000	1000	1000	1000	1000	1000	1000	1000	1000	1000	1000	1000	1000	1000	1000	1000	999	997	987	980	962	951

LM53 SHR C0-C180: 1.120 SHR C90-C270: 1.120 SHR Superficial: 1.265

Luminaria

Código 10-A004-05-15V2_2700

Nombre LEVELS

Ensayo

Código 10-A004-05-15V2_2700

Nombre LEVELS

Flujo Luminaria	936 lm	Potencia Luminaria	14.7 W	Eficacia	63.673 lm/W	Eficiencia	100.00%
Flujo Fuente	936 lm	Valor Máximo	365.05 cd/klm	Posición	C=0.00 G=13.00	CG	Rotosimétrico

Apertura a 50.00 % de Max Intensidad

H[m]	1.00	2.00	3.00	4.00	5.00	H[m]	1.00	2.00	3.00	4.00	5.00
OA	1.26	2.53	3.79	5.06	6.32	OC	1.26	2.53	3.79	5.06	6.32
OB	1.26	2.53	3.79	5.06	6.32	OD	1.26	2.53	3.79	5.06	6.32

Intensidades Luminosas [cd/klm]

	0	5	15	25	35	45	55	65	75	85
OA	340.52	339.37	340.74	286.20	227.97	195.43	158.10	118.09	75.10	40.00
OB	340.52	339.37	340.74	286.20	227.97	195.43	158.10	118.09	75.10	40.00
OC	340.52	339.37	340.74	286.20	227.97	195.43	158.10	118.09	75.10	40.00
OD	340.52	339.37	340.74	286.20	227.97	195.43	158.10	118.09	75.10	40.00

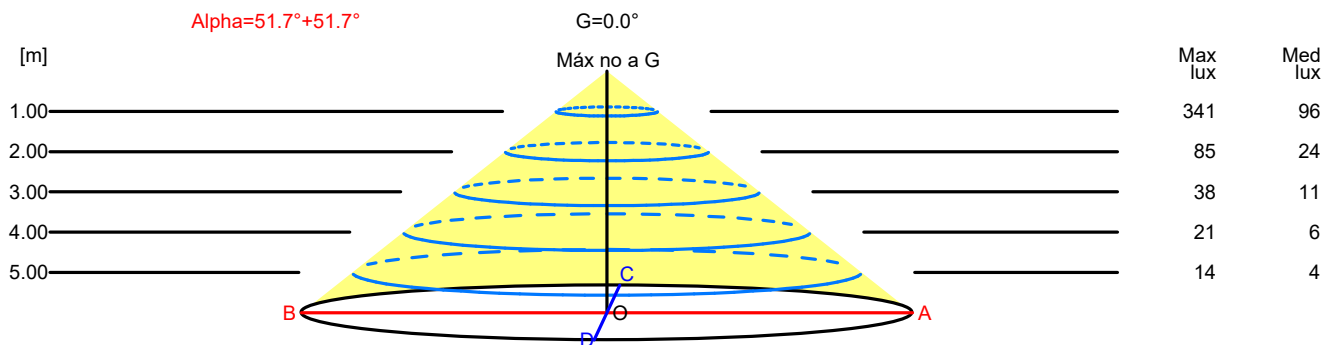

H[m]	D[m]	Max lux	Med lux	Alpha=51.7°+51.7°	G=0.0 Máx no a G
1.00	2.53	341	96		
2.00	5.06	85	24		
3.00	7.59	38	11		
4.00	10.12	21	6		
5.00	12.65	14	4		

Luminaria

Código 10-A004-05-15V2_2700

Nombre LEVELS

Ensayo

Código 10-A004-05-15V2_2700

Nombre LEVELS

Flujo Luminaria	936 lm	Potencia Luminaria	14.7 W	Eficacia	63.673 lm/W	Eficiencia	100.00%
Flujo Fuente	936 lm	Valor Máximo	365.05 cd/klm	Posición	C=0.00 G=13.00	CG	Rotosimétrico

Isolux (Suelo)

Posición Luminaria X=0.00m Y=0.00m Z=2.50m

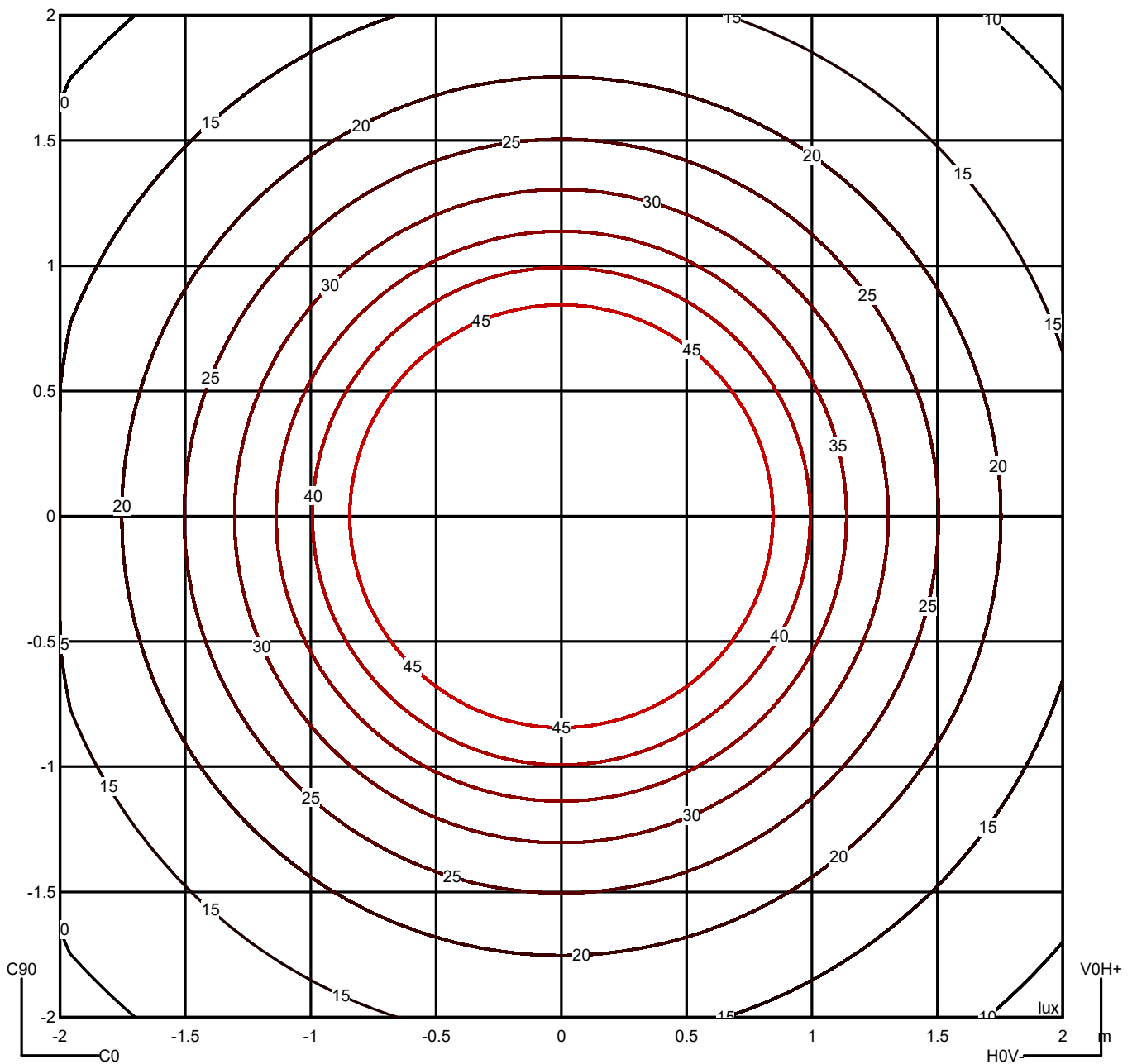

Luminaria

Código 10-A004-05-15V2_2700

Nombre LEVELS

Ensayo

Código 10-A004-05-15V2_2700

Nombre LEVELS

Flujo Luminaria	936 lm	Potencia Luminaria	14.7 W	Eficacia	63.673 lm/W	Eficiencia	100.00%
Flujo Fuente	936 lm	Valor Máximo	365.05 cd/klm	Posición	C=0.00 G=13.00	CG	Rotosimétrico

Luminancia

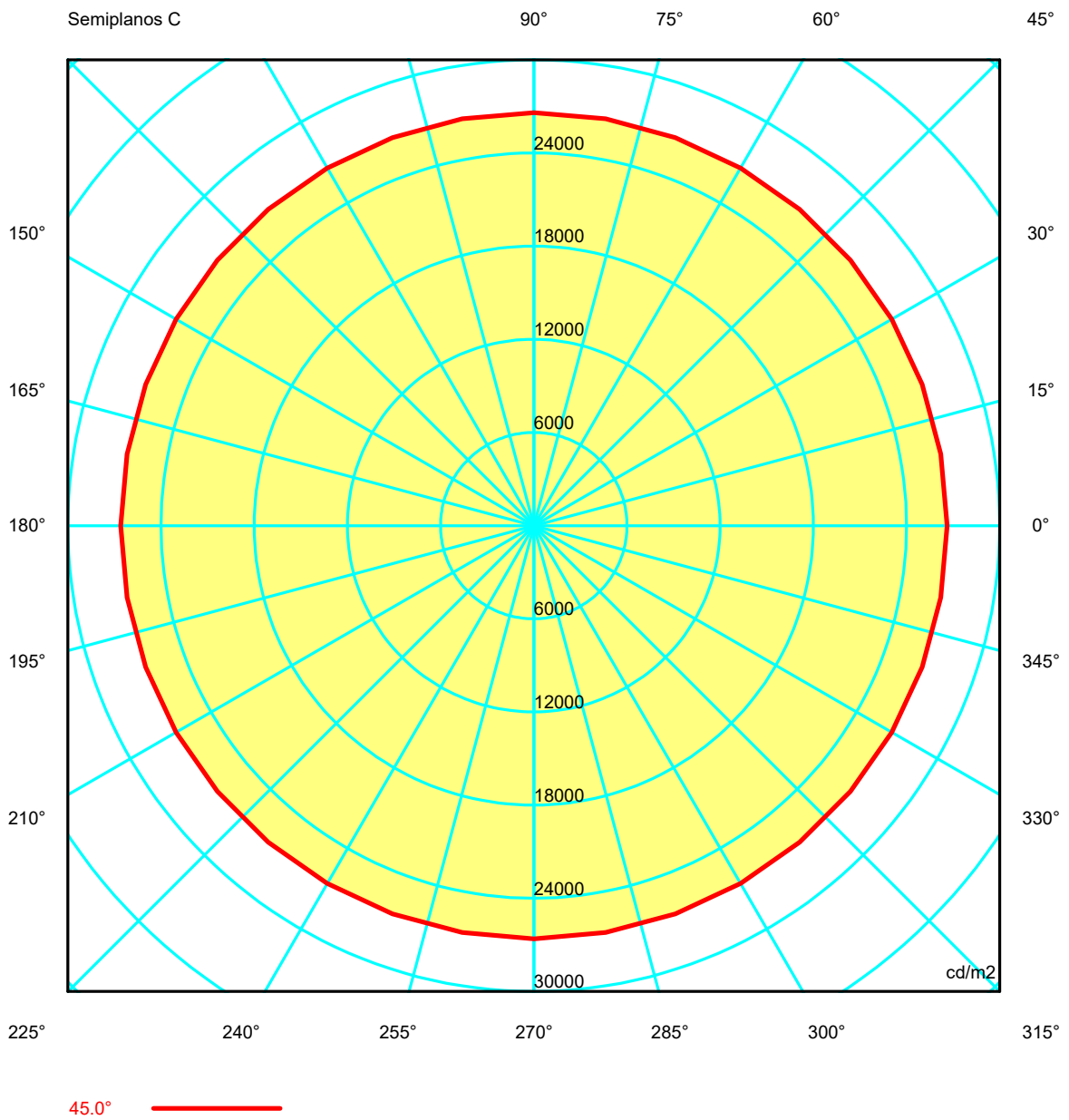

Luminaria

Código 10-A004-05-15V2_2700

Nombre LEVELS

Ensayo

Código 10-A004-05-15V2_2700

Nombre LEVELS

Flujo Luminaria	936 lm	Potencia Luminaria	14.7 W	Eficacia	63.673 lm/W	Eficiencia	100.00%
Flujo Fuente	936 lm	Valor Máximo	365.05 cd/klm	Posición	C=0.00 G=13.00	CG	Rotosimétrico

Luminance cd/m2 Tabla 1/3

	C 0.00	C 10.00	C 20.00	C 30.00	C 40.00	C 50.00	C 60.00	C 70.00	C 80.00	C 90.00	C 100.00	C 110.00	C 120.00
G 0.0	32783	32783	32783	32783	32783	32783	32783	32783	32783	32783	32783	32783	32783
G 5.0	32798	32798	32798	32798	32798	32798	32798	32798	32798	32798	32798	32798	32798
G 10.0	33076	33076	33076	33076	33076	33076	33076	33076	33076	33076	33076	33076	33076
G 15.0	33962	33962	33962	33962	33962	33962	33962	33962	33962	33962	33962	33962	33962
G 20.0	33105	33105	33105	33105	33105	33105	33105	33105	33105	33105	33105	33105	33105
G 25.0	30403	30403	30403	30403	30403	30403	30403	30403	30403	30403	30403	30403	30403
G 30.0	28270	28270	28270	28270	28270	28270	28270	28270	28270	28270	28270	28270	28270
G 35.0	26793	26793	26793	26793	26793	26793	26793	26793	26793	26793	26793	26793	26793
G 40.0	26353	26353	26353	26353	26353	26353	26353	26353	26353	26353	26353	26353	26353
G 45.0	26608	26608	26608	26608	26608	26608	26608	26608	26608	26608	26608	26608	26608
G 50.0	26536	26536	26536	26536	26536	26536	26536	26536	26536	26536	26536	26536	26536
G 55.0	26538	26538	26538	26538	26538	26538	26538	26538	26538	26538	26538	26538	26538
G 60.0	26704	26704	26704	26704	26704	26704	26704	26704	26704	26704	26704	26704	26704
G 65.0	26902	26902	26902	26902	26902	26902	26902	26902	26902	26902	26902	26902	26902
G 70.0	27159	27159	27159	27159	27159	27159	27159	27159	27159	27159	27159	27159	27159
G 75.0	27936	27936	27936	27936	27936	27936	27936	27936	27936	27936	27936	27936	27936
G 80.0	30684	30684	30684	30684	30684	30684	30684	30684	30684	30684	30684	30684	30684
G 85.0	44191	44191	44191	44191	44191	44191	44191	44191	44191	44191	44191	44191	44191
G 90.0	0	0	0	0	0	0	0	0	0	0	0	0	0

Luminaria

Código 10-A004-05-15V2_2700

Nombre LEVELS

Ensayo

Código 10-A004-05-15V2_2700

Nombre LEVELS

Flujo Luminaria	936 lm	Potencia Luminaria	14.7 W	Eficacia	63.673 lm/W	Eficiencia	100.00%
Flujo Fuente	936 lm	Valor Máximo	365.05 cd/klm	Posición	C=0.00 G=13.00	CG	Rotosimétrico

Luminance cd/m2 Tabla 2/3

	C 130.00	C 140.00	C 150.00	C 160.00	C 170.00	C 180.00	C 190.00	C 200.00	C 210.00	C 220.00	C 230.00	C 240.00	C 250.00
G 0.0	32783	32783	32783	32783	32783	32783	32783	32783	32783	32783	32783	32783	32783
G 5.0	32798	32798	32798	32798	32798	32798	32798	32798	32798	32798	32798	32798	32798
G 10.0	33076	33076	33076	33076	33076	33076	33076	33076	33076	33076	33076	33076	33076
G 15.0	33962	33962	33962	33962	33962	33962	33962	33962	33962	33962	33962	33962	33962
G 20.0	33105	33105	33105	33105	33105	33105	33105	33105	33105	33105	33105	33105	33105
G 25.0	30403	30403	30403	30403	30403	30403	30403	30403	30403	30403	30403	30403	30403
G 30.0	28270	28270	28270	28270	28270	28270	28270	28270	28270	28270	28270	28270	28270
G 35.0	26793	26793	26793	26793	26793	26793	26793	26793	26793	26793	26793	26793	26793
G 40.0	26353	26353	26353	26353	26353	26353	26353	26353	26353	26353	26353	26353	26353
G 45.0	26608	26608	26608	26608	26608	26608	26608	26608	26608	26608	26608	26608	26608
G 50.0	26536	26536	26536	26536	26536	26536	26536	26536	26536	26536	26536	26536	26536
G 55.0	26538	26538	26538	26538	26538	26538	26538	26538	26538	26538	26538	26538	26538
G 60.0	26704	26704	26704	26704	26704	26704	26704	26704	26704	26704	26704	26704	26704
G 65.0	26902	26902	26902	26902	26902	26902	26902	26902	26902	26902	26902	26902	26902
G 70.0	27159	27159	27159	27159	27159	27159	27159	27159	27159	27159	27159	27159	27159
G 75.0	27936	27936	27936	27936	27936	27936	27936	27936	27936	27936	27936	27936	27936
G 80.0	30684	30684	30684	30684	30684	30684	30684	30684	30684	30684	30684	30684	30684
G 85.0	44191	44191	44191	44191	44191	44191	44191	44191	44191	44191	44191	44191	44191
G 90.0	0	0	0	0	0	0	0	0	0	0	0	0	0

Luminaria

Código 10-A004-05-15V2_2700
Nombre LEVELS

Ensayo

Código 10-A004-05-15V2_2700
Nombre LEVELS

Flujo Luminaria	936 lm	Potencia Luminaria	14.7 W	Eficacia	63.673 lm/W	Eficiencia	100.00%
Flujo Fuente	936 lm	Valor Máximo	365.05 cd/klm	Posición	C=0.00 G=13.00	CG	Rotosimétrico

Luminance cd/m2 Tabla 3/3

	C 260.00	C 270.00	C 280.00	C 290.00	C 300.00	C 310.00	C 320.00	C 330.00	C 340.00	C 350.00
G 0.0	32783	32783	32783	32783	32783	32783	32783	32783	32783	32783
G 5.0	32798	32798	32798	32798	32798	32798	32798	32798	32798	32798
G 10.0	33076	33076	33076	33076	33076	33076	33076	33076	33076	33076
G 15.0	33962	33962	33962	33962	33962	33962	33962	33962	33962	33962
G 20.0	33105	33105	33105	33105	33105	33105	33105	33105	33105	33105
G 25.0	30403	30403	30403	30403	30403	30403	30403	30403	30403	30403
G 30.0	28270	28270	28270	28270	28270	28270	28270	28270	28270	28270
G 35.0	26793	26793	26793	26793	26793	26793	26793	26793	26793	26793
G 40.0	26353	26353	26353	26353	26353	26353	26353	26353	26353	26353
G 45.0	26608	26608	26608	26608	26608	26608	26608	26608	26608	26608
G 50.0	26536	26536	26536	26536	26536	26536	26536	26536	26536	26536
G 55.0	26538	26538	26538	26538	26538	26538	26538	26538	26538	26538
G 60.0	26704	26704	26704	26704	26704	26704	26704	26704	26704	26704
G 65.0	26902	26902	26902	26902	26902	26902	26902	26902	26902	26902
G 70.0	27159	27159	27159	27159	27159	27159	27159	27159	27159	27159
G 75.0	27936	27936	27936	27936	27936	27936	27936	27936	27936	27936
G 80.0	30684	30684	30684	30684	30684	30684	30684	30684	30684	30684
G 85.0	44191	44191	44191	44191	44191	44191	44191	44191	44191	44191
G 90.0	0	0	0	0	0	0	0	0	0	0

Luminaria

Código 10-A004-05-15V2_2700

Nombre LEVELS

Ensayo

Código 10-A004-05-15V2_2700

Nombre LEVELS

Flujo Luminaria	936 lm	Potencia Luminaria	14.7 W	Eficacia	63.673 lm/W	Eficiencia	100.00%
Flujo Fuente	936 lm	Valor Máximo	365.05 cd/klm	Posición	C=0.00 G=13.00	CG	Rotosimétrico

US ROAD STANDARDS

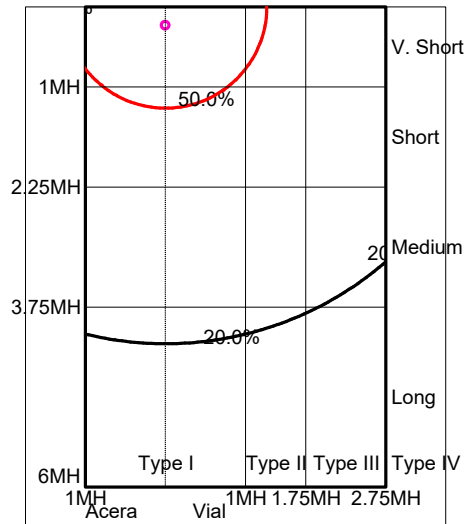
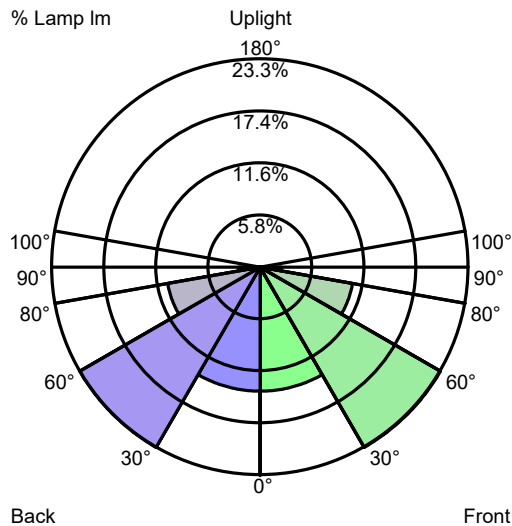

Luminaire Classification System (LCS)			
LCS Zone		Lumens	%Lamp
FL	0° -- 30°	129.8 lm	13.9 %
FM	30° -- 60°	217.7 lm	23.3 %
FH	60° -- 80°	98.2 lm	10.5 %
FVH	80° -- 90°	22.3 lm	2.4 %
BL	0° -- 30°	129.8 lm	13.9 %
BM	30° -- 60°	217.7 lm	23.3 %
BH	60° -- 80°	98.2 lm	10.5 %
BVH	80° -- 90°	22.3 lm	2.4 %
UL	90° -- 100°	0.0 lm	0.0 %
UH	100° -- 180°	0.0 lm	0.0 %
TOTALS		936.0 lm	100.0 %
BUG B1 U0 G1 Type V Very Short Quadrilateral Symmetry			



Levels

TABLE

